



Basket World

SPORTSYSTEM
WWW.SPORTSYSTEM.®



BVBA SPORTA DE WAELE

Gentsesteenweg 190

9240 ZELE-België/Belgique/Belgium

Fabriek van sport-, turn- & fitnessstoestellen

☎ 052/44 43 38

✉ sportadewaele@skynet.be

Indice

Dal 1979 **Sport System** progetta, produce, distribuisce ed installa, in Italia e nel resto del mondo, una vasta gamma di **attrezzature ed articoli sportivi per la ginnastica, l'atletica, gli sport individuali e di squadra, oltre ad una linea completa di arredi ed accessori funzionali al completamento dei locali annessi alle aree di gioco.**

Il presente catalogo, articolato in 4 principali categorie (**Ginnastica, Atletica, Giochi, Arredi**) a loro volta suddivise in diverse sottocategorie, vuole presentare con precisione l'attuale offerta di **Sport System**, in costante sviluppo, con evidenziazione delle molteplici novità (contrassegnate con **NEW**).

I prodotti rappresentati nel presente documento potrebbero essere soggetti a variazioni, migliorative, apportate nell'ottica di un continuo perfezionamento.

Table of contents

*Since 1979 **Sport System** have been designing, manufacturing, trading and installing, in Italy and internationally, a **wide range of sports equipment for gymnastics, athletics, individual and team sports as well as a complete range of furnishing and accessories.***

This enables customers to entirely equip, not only the sports court, but any sporting venue from the spectators' area to changing rooms, from infirmaries to meeting and press rooms.

*The catalogue consists of 4 main categories: **Gymnastics, Athletics, Games and Furniture.***

*Each category is divided into several sub categories representing the current **Sport System**'s offer.*

*Company is always adapting and innovating, seeking to offer improved solutions (tagged **NEW**).*

Because of these continuous improvements some of the products may vary slightly from the images shown.

GINNASTICA

GINNASTICA ARTISTICA

- Anelli **8**
- Assi e travi di equilibrio **9**
- Cavalli, cavalline, corsie di rincorsa **10**

- Parallele **11**
- Pedane elastiche, pedane corpo libero **13**
- Sbarre orizzontali per volteggi **14**

GINNASTICA GENERALE

- Appoggi e ceppi **14**
- Armadi e mobili porta attrezzi **15**
- Bastoni **16**
- Cerchi **17**
- Clavette **18**
- Funi, funicelle **18**
- Materassi, tappeti, tatami, stuoie **19**
- Palchi di salita, articoli per arrampicata **24**
- Palle mediche, palle mediche attrezzate **26**
- Panche, panche svedesi **27**
- Plinti **28**
- Quadri svedesi **28**
- Scale **29**
- Spalliere e articoli in legno **29**
- Trampolini **32**

GINNASTICA RITMICA E AEROBICA

- Palle e accessori per ginnastica ritmica **33**
- Accessori per ginnastica aerobica **34**

GINNASTICA PROPRIOCETTIVA, YOGA, PILATES

- Accessori per ginnastica propriocettiva **34**
- Accessori per Yoga e Pilates **35**

GINNASTICA PSICOMOTORIA, PRIMA INFANZIA, TERZA ETA'

- Percorsi ed accessori per attività psicomotorie **36**
- Figure geometriche in gomma **37**
- Palle psicomotricità, air ball, palle con maniglia e varie **38**

DANZA

- Sbarre danza e supporti **40**
- Specchi **40**

FITNESS

- Bilancieri, manubri, accessori **41**
- Panche per addominali e sollevamento pesi, multifunzione **43**
- Accessori potenziamento muscolare **44**
- Articoli per boxe **44**

GYMNASTICS

ARTISTIC GYMNASTIC

- Rings **8**
- Balance beams **9**
- Vaulting and pommel horses, vaulting bucks, run up tracks **10**
- Parallel and asymmetric bars **11**
- Springboards, gymnastic floors **13**
- Horizontal high bars **14**

GENERAL GYMNASTIC

- Baumann supports and blocks **14**
- Equipment lockers and trolleys **15**
- Gymnastic sticks **16**
- Gymnastic hoops **17**
- Gymnastic clubs **18**
- Ropes **18**
- Gym and landing mats, tatamis, individual mats **19**
- Climbing apparatus, climbing equipment **24**
- Medicine balls, medicine balls with rope **26**
- Gym benches **27**
- Vaulting boxes **28**
- Swedish runged wall bars **28**
- Wall ladders **29**
- Wall bars and wooden equipment **29**
- Trampolines **32**

RHYTHMIC AND AEROBIC GYMNASTIC

- Balls and accessories for rhythmic gymnastic **33**
- Accessories for aerobic gymnastic **34**

REHABILITATION GYMNASTIC, YOGA, PILATES

- Accessories for rehabilitation gymnastic **34**
- Accessories for Yoga and Pilates **35**

PSYCHOMOTOR GYMNASTIC, FIRST AGES, SENIOR GYMNASTIC

- Equipment for psychomotor activities **36**
- Soft geometric construction elements **37**
- Psychomotor balls, air balls, bouncing balls and other balls **38**

BALLET

- Ballet barres and supports **40**
- Mirrors **40**

FITNESS

- Barbells, dumbbells, accessories **41**
- Abdominal and weightlifting benches, multigym **43**
- Accessories for fitness **44**
- Boxing equipment **44**

ATLETICA

DISCIPLINE SU PISTA

- Blocchi di partenza, testimoni
- Ostacoli
- Scale e accessori per giudici
- Cronometri e articoli per rilevazione tempi
- Articoli vari per discipline su pista
- Rotelle metriche

DISCIPLINE DA LANCIO

- Articoli per lancio del disco
- Articoli per lancio del giavellotto
- Articoli per lancio del martello
- Articoli per getto del peso

SALTO IN ALTO, SALTO CON L'ASTA, SALTO IN LUNGO E TRIPLO

- Articoli per salto in alto
- Articoli per salto con l'asta
- Articoli per salto in lungo e triplo

ATHLETICS

TRACK EVENTS

- 48** Starting blocks, relay batons
- 48** Hurdles
- 50** Stands and accessories for referees
- 52** Stopwatches and timing equipment
- 52** Accessories for track events
- 54** Measuring tapes

THROWING EVENTS

- 54** Discus throwing equipment
- 56** Javelin throwing equipment
- 57** Hammer throwing equipment
- 58** Shot put equipment

HIGH JUMP, POLE VAULT, LONG AND TRIPLE JUMP

- 60** High jump equipment
- 61** Pole vault equipment
- 63** Long and triple jump equipment

GIOCHI

BASKET E MINIBASKET

- Strutture ricreative basket, minibasket e baskin
- Impianti basket a traliccio e monotubolari
- Impianti basket a parete e a soffitto
- Impianti basket mobili su ruote
- Impianti minibasket
- Tabelloni basket e minibasket, protezioni, canestri, retine
- Panchine per giocatori, tavoli giuria, accessori
- Articoli allenamento basket

CALCIO E CALCIO RIDOTTO

- Porte calcio e calcio ridotto, accessori
- Reti per porte calcio e calcio ridotto
- Panchine per riserve ed allenatori
- Accessori per arbitro
- Articoli per allenamento gioco calcio
- Carrelli segna campo, bandierine calcio angolo, accessori campi calcio

CALCETTO PALLAMANO

GAMES

BASKET AND MINI-BASKET

- 66** Recreational basket, mini-basket and baskin units
- 67** Olympic and monotubular basketball backstops
- 70** Wall and roof mounted basketball backstops
- 73** Portable basketball backstops
- 81** Mini-basket backstops
- 83** Basket and mini-basket backboards, protective pads, rings, nets
- 87** Players benches, judges tables, accessories
- 91** Training accessories for basket

SOCCER AND REDUCED SOCCER

- 93** Standard and reduced soccer goals, accessories
- 96** Nets for standard and reduced soccer goals
- 97** Team shelters
- 105** Accessories for referee
- 106** Accessories for training
- 110** Pitch marker trolleys, corner flags, accessories for soccer field

FUTSAL HANDBALL

VOLLEY E MINIVOLLEY	116	VOLLEY AND MINIVOLLEY	
Impianti pallavolo e protezioni		<i>Volley posts and protective pads</i>	
Reti e accessori	120	<i>Nets and accessories</i>	
Articoli per arbitro ed allenatore	122	<i>Accessories for referee and coach</i>	
Pali minivolley e reti	126	<i>Minivolley posts and nets</i>	
TENNIS E PADEL		TENNIS AND PADEL	
Tennis e Padel - pali e reti	127	<i>Tennis and Padel - posts and nets</i>	
Sedia per arbitro, panchine e articoli vari campo tennis	129	<i>Referee platforms, benches and other equipment for tennis court</i>	
BADMINTON	132	BADMINTON	
SPORT DA SPIAGGIA		BEACH SPORTS	
Articoli per beach handball e beach soccer	132	<i>Beach handball and beach soccer equipment</i>	
Articoli per beach volley e beach tennis	133	<i>Beach volley and beach tennis equipment</i>	
STREETBALL - 3ON3	136	STREETBALL - 3ON3	
HOCKEY, UNIHOCKEY	141	HOCKEY, UNIHOCKEY	
RUGBY	142	RUGBY	
BASEBALL	142	BASEBALL	
NUOTO E PALLANUOTO	143	SWIMMING AND WATERPOLO	
MULTISPORT	145	MULTISPORT	
NETBALL	146	NETBALL	
TENNIS TAVOLO E GIOCHI DA SALA		TABLE TENNIS AND LEISURE GAMES	
Articoli tennis tavolo	147	<i>Table tennis equipment</i>	
Calcio balilla e Carambole	148	<i>Table football and Pool tables</i>	
TABELLONI ELETTRONICI E DISPLAY LED	149	ELECTRONIC SCOREBOARDS AND LED DISPLAY	
PALLONI		BALLS	
Palloni basket e minibasket	157	<i>Basket and mini-basket balls</i>	
Palloni calcio e calcetto	158	<i>Soccer and futsal balls</i>	
Palloni pallamano	159	<i>Handball balls</i>	
Palloni volley e minivolley	159	<i>Volley and minivolley balls</i>	
Palloni per sport da spiaggia, rugby e pallanuoto	160	<i>Balls for beach sports, rugby and waterpolo</i>	
Cesti porta palloni, accessori di gonfiaggio	161	<i>Balls trolleys, inflating accessories</i>	
ABBIGLIAMENTO SPORTIVO ED ACCESSORI	162	APPAREL AND ACCESSORIES	

ARREDI

FURNITURE

ARMADI PORTA ATTREZZI	166	EQUIPMENT LOCKERS
ARREDO INFIRMERIA	167	FURNITURE FOR INFIRMARY
ARREDO SPOGLIATOIO		FURNITURE FOR LOCKER ROOM
Armadi spogliatoio in lamiera	171	<i>Sheet steel wardrobes and lockers</i>
Armadi spogliatoio in laminato	173	<i>HPL wardrobes</i>
Cabine spogliatoio VIP	174	<i>VIP locker room modules</i>
Panchine spogliatoio con struttura di acciaio	175	<i>Steel structure benches</i>
Panchine spogliatoio con struttura di alluminio	178	<i>Aluminium structure benches</i>
Accessori per spogliatoio	179	<i>Accessories for locker room</i>
PROTEZIONI MURALI E BORDO CAMPO	183	WALL AND BOUNDARY PROTECTIONS
RETI DIVISORIE E DI PROTEZIONE	185	DIVIDING AND BOUNDARY NETS
TENDE E PANNELLI DIVISORI	186	DIVIDING CURTAINS AND PANELS
TRIBUNE FISSE, TELESCOPICHE E TRASPORTABILI	190	FIXED, TELESCOPIC AND PORTABLE STANDS
SCOCHE E SEDUTE VIP	196	POLYPROPYLENE AND VIP SEATS
TRANSENNE E SISTEMI DI PULIZIA	198	BARRIERS AND CLEANING TOOLS

SPORT SYSTEM

SPORT SYSTEM

L'AZIENDA	202	COMPANY PROFILE
ALCUNE REFERENZE	204	SOME REFERENCES

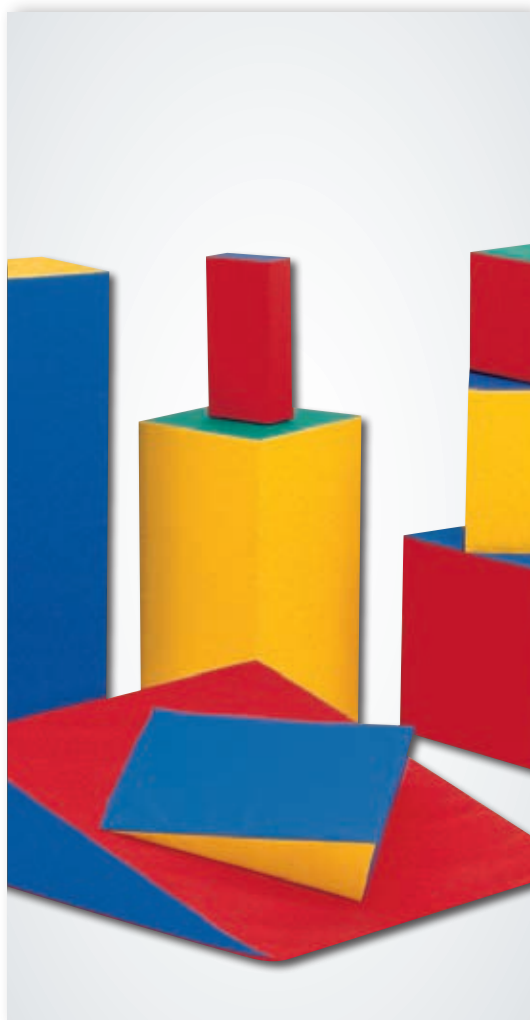

GINNASTICA

Una linea completa di attrezzature ed articoli per la pratica delle varie discipline della **ginnastica scolastica**, della **ginnastica artistica**, **aerobica** e **ritmica** con una selezione di attrezzature ed **articoli omologati FIG per competizioni**. La categoria comprende altresì articoli per la **ginnastica in età pre-scolare** e per la **ginnastica nella terza età** oltre ad accessori per **danza**, **Yoga** e **Pilates**. Gli ultimi capitoli sono dedicati infine al **fitness** ed alla **boxe**.



GYMNASTICS

*A complete range of equipment and accessories for practicing the disciplines of **standard school's gymnastics** as well as **artistic**, **aerobic** and **rhythmic gymnastics**.*

*A selection of **FIG approved equipment** is included. This category includes, as well products for **junior** and **senior gymnastics**, also **accessories for ballet**, **Yoga** and **Pilates**. The last titles are dedicated to **fitness** and **boxing**.*



1

Anelli Rings



S00002

S00002

Coppia anelli di legno lamellare
Pair of varnished laminated wood rings



S00004

S00004

Coppia funi di canapa per anelli
(anelli esclusi)
Pair of hemp ropes suitable for rings
(rings not included)



S00006

S00006

Coppia funi di nylon con snodi per anelli
(anelli compresi)
Pair of jointed nylon ropes suitable for
rings (rings included)



S00008

S00008

Mensola a muro per sospensione anelli
ad altezza fissa (anelli e funi esclusi)
Wall mounted support sustaining rings
at fixed height (rings and ropes not
included)



S00010

S00010

Mensola a muro per sospensione
anelli ad altezza regolabile (anelli e funi
esclusi)
Wall mounted support sustaining rings
at adjustable height (rings and ropes not
included)

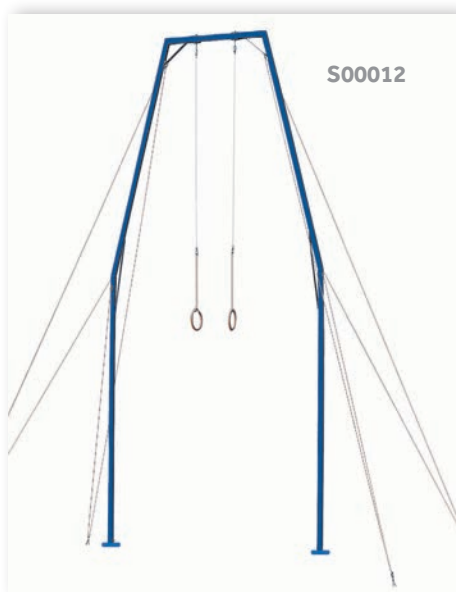

S00012

S00012

Castello per anelli di acciaio
verniciato (anelli e funi esclusi)
Varnished steel rings' frame
(rings and ropes not included)

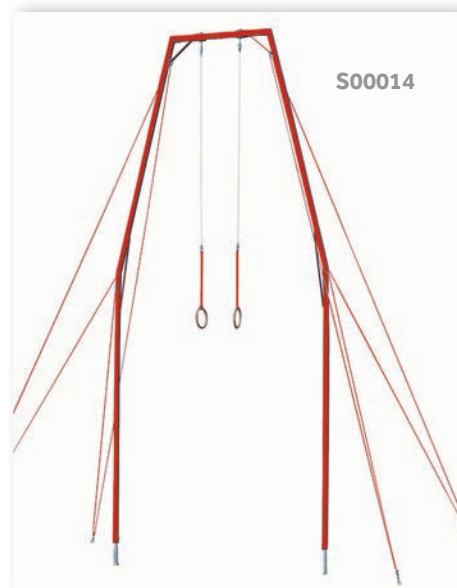

S00014

S00014

Castello per anelli omologato
FIG per competizioni (anelli e funi
compresi)
Varnished steel rings' frame FIG
approved for competition (rings and
ropes included)



S00016

S00016

Carrello porta magnesio in acciaio
verniciato, mobile su ruote
Varnished steel chalk container
mobile on wheels



S00018

S00018

Magnesio in confezione di 8 pani
Chalk blocks in package of 8 pcs

2

Assi e travi di equilibrio Balance beams

S00052

Asse di equilibrio in legno, altezza fissa cm 30, lunghezza mt 3
Wooden training balance beam, 3 mt long, fixed height 30 cm

S00054

Asse di equilibrio in legno, altezza fissa cm 30, lunghezza mt 4
Wooden training balance beam, 4 mt long, fixed height 30 cm



S00056

S00056
ZOOM

S00056

Asse di equilibrio in legno, altezza fissa cm 30, lunghezza mt 5
Wooden training balance beam, 5 mt long, fixed height 30 cm



S00058

S00058

Asse di equilibrio in legno, altezza regolabile cm 30/50, lunghezza mt 5
Wooden training balance beam, 5 mt long, adjustable height 30/50 cm

S00059



S00059

Trave di equilibrio in alluminio rivestito, supporto a terra, lunghezza mt 5
Aluminium balance beam padded and covered, 5 mt long, ground level support



S00060

S00060

Trave di equilibrio in alluminio rivestito ad altezza fissa cm 50, lunghezza mt 5
Aluminium balance beam padded and covered, 5 mt long, fixed height 50 cm



S00061

S00061

Trave di equilibrio in alluminio rivestito ad altezza fissa cm 125, lunghezza mt 5
Aluminium balance beam padded and covered, 5 mt long, fixed height 125 cm

NEW



S00062

S00062

Trave di equilibrio in alluminio rivestito ad altezza regolabile cm 80/120, lunghezza mt 5
Aluminium balance beam padded and covered, 5 mt long, adjustable height 80/120 cm



S00064



S00064 - ZOOM

S00064

Trave di equilibrio in alluminio rivestito ad altezza regolabile cm 50/120, lunghezza mt 5, a norme FIG
Aluminium balance beam padded and covered, 5 mt long, adjustable height 50/120 cm, in accordance to FIG rules



S00066

S00066

Trave di equilibrio omologata FIG per competizioni ad altezza regolabile cm 90/140, lunghezza mt 5

Aluminium balance beam FIG approved for competition, 5 mt long, adjustable height 90/140 cm

S00068

**S00068**

Carrello in acciaio verniciato per trasporto trave

Varnished steel trolley for balance beam

S00070

**S00070**

Rivestimento per trave di skay scamosciato

Removable cover for beam's body made of suede synthetic leather

3

Cavalli, cavalline, corsie di rincorsa **Vaulting and pommel horses, vaulting bucks, run up tracks**



S00102

S00102

Cavallo per volteggio senza maniglie, rivestito di cuoio naturale, altezza regolabile

Vaulting horse, covered with natural leather, adjustable height

S00104

Cavallo per volteggio senza maniglie, rivestito di cuoio sintetico, altezza regolabile

Vaulting horse, covered with synthetic leather, adjustable height



S00106

S00106

Cavallo con maniglie, rivestito di cuoio naturale, altezza regolabile

Pommel horse, covered with natural leather, adjustable height

S00108

Cavallo con maniglie, rivestito di cuoio sintetico, altezza regolabile

Pommel horse, covered with synthetic leather, adjustable height

S00110

Cavallo olimpionico per volteggio, rivestito di finta pelle scamosciata, altezza regolabile

Olympic vaulting horse, covered with suede like leather, adjustable height

S00112

**S00112**

Cavallo olimpionico con maniglie, rivestito di finta pelle scamosciata, altezza regolabile

Olympic pommel horse, covered with suede like leather, adjustable height



S00114

S00114

Cavallo con maniglie omologato FIG per competizioni, rivestito di cuoio naturale, altezza regolabile

Pommel horse FIG approved for competition, covered with natural leather, adjustable height



S00116

S00116

Coppia maniglie per cavallo in poliammide e vetroresina

Pair of polyamide and fibreglass pommels for pommel horse

S00122

Cavallina regolamentare, rivestita di cuoio naturale, altezza regolabile (Bassa)

Vaulting buck, covered with natural leather, adjustable height (Low)

S00123

Cavallina regolamentare, rivestita di cuoio naturale, altezza regolabile (Alta)

Vaulting buck, covered with natural leather, adjustable height (High)

S00128

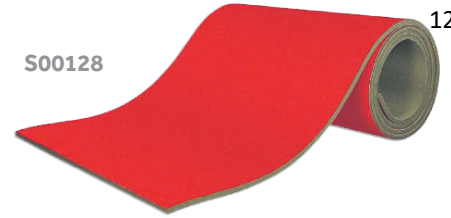
**S00128**

Corsia di rincorsa arrotolabile in poliuretano e moquette, spessore mm 25, dimensioni mt 25x1

Rollable run-up track made of polyurethane foam covered with carpet, thickness 25 mm, dimensions 25x1 mt



S00120

S00120

Tavolo per volteggi omologato FIG per competizioni, rivestito in materiale bicolore ed antiscivolo, regolabile in altezza

Vaulting table FIG approved for competition, bi-coloured and anti-slip body, central leg adjustable in height



S00124

S00124

Cavallina regolamentare, rivestita di cuoio sintetico, altezza regolabile (Bassa)

Vaulting buck, covered with synthetic leather, adjustable height (Low)

S00125

Cavallina regolamentare, rivestita di cuoio sintetico, altezza regolabile (Alta)

Vaulting buck, covered with synthetic leather, adjustable height (High)

S00130

Corsia di rincorsa arrotolabile in poliuretano e moquette, spessore mm 35, dimensioni mt 15x2

Rollable run-up track made of polyurethane foam covered with carpet, thickness 35 mm, dimensions 15x2 mt

S00132

**S00132**

Cubone per volteggi, dimensioni cm 200x100x80, densità 16

Soft vaulting cube, dimensions 200x100x80 cm, density 16

4

Parallele - Parallel and asymmetric bars

S00152

S00152

Parallela maschile in acciaio verniciato su basamento pesante, staggi di legno lamellare regolabili in altezza e larghezza

Parallel bars, varnished steel construction with heavy base, laminated wood bars adjustable in height and width



S00154

S00154

Parallela maschile omologata FIG per competizioni, robusta struttura di acciaio verniciato, regolazione in altezza e larghezza degli staggi

Parallel bars FIG approved for competition, reinforced varnished steel frame, easy adjustment of bars' height and width



S00156

S00156

Parallela asimmetrica femminile in acciaio verniciato su basamento pesante, staggi di legno lamellare regolabili in altezza e larghezza

Asymmetric bars, varnished steel construction with heavy base, laminated wood bars adjustable in height and width



S00158

S00158

Parallela asimmetrica femminile omologata FIG per competizioni, struttura di acciaio verniciato con tiranti, regolazione in altezza e larghezza degli staggi

Asymmetric bars FIG approved for competition, varnished steel construction with cables, bars adjustable in height and width

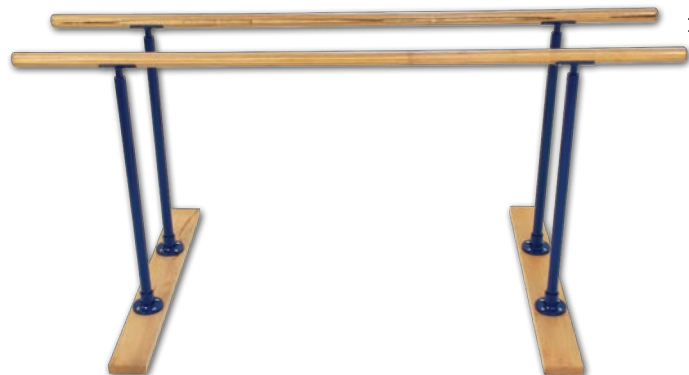

S00160

**S00160**

Parallela scolastica da allenamento, modello a losanga, staggi in legno lamellare ad altezza fissa

Practice parallel bars with light varnished steel structure on wooden base, laminated wood bars at fixed height

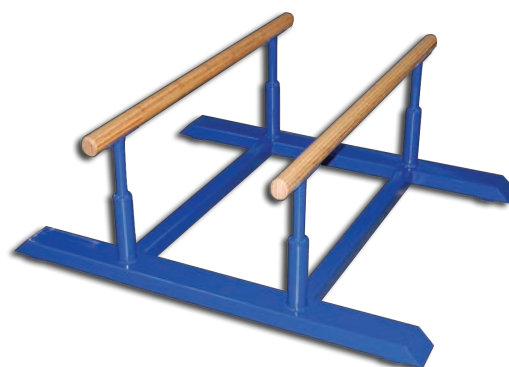

S00162

S00162

Mini parallela da allenamento ad altezza fissa cm 40, staggi in legno lamellare lunghezza cm 120

Mini parallel bars for training, fixed height 40 cm, laminated wood bars length 120 cm

S00164

**S00164**

Staggio per parallela in legno lamellare, lunghezza cm 350

Laminated wood bar for parallel and asymmetric bars, 350 cm long

S00168

**S00168**

Carrello in acciaio verniciato per trasporto parallele S00152 e S00156
Varnished steel trolley for parallel and asymmetric bars S00152 and S00156

S00206

Pedana elastica con piano di battuta ricoperto di gomma
Springboard with rubber covered surface

S00208

**S00208**

Pedana elastica con piano di battuta ricoperto di moquette
Springboard with carpet covered surface

S00210

**S00210**

Pedana elastica a doppio molleggio, piano di battuta rivestito di moquette
Double effort springboard with carpet covered surface

S00211

**S00211**

Protezione frontale a "U" per pedana elastica, in gomma rivestita PVC
Soft pad "U" shaped for springboard, made in foam covered PVC

S00212

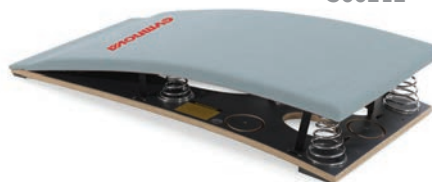
**S00212**

Pedana elastica olimpionica omologata FIG per competizioni, piano di battuta imbottito e rivestito
Olympic springboard FIG approved for competition with padded and carpet covered surface



S00214

S00214

Pedana per ginnastica artistica omologata FIG per competizioni, dimensioni mt 14x14, spessore totale cm 14,5

Artistic gymnastic exercise floor FIG approved for competition, dimensions 14x14 mt, total thickness 14.5 cm

S00216

Pedana per allenamento corpo libero e ginnastica artistica con dimensioni mt 14x14, spessore mm 35, in rotoli da cm 200

Rollable mat floor for practicing artistic gymnastic exercises, dimensions 14x14 mt, thickness 35 mm, in rolls of 200 cm

S00218

**S00218**

Tappeto arrotolabile per pedana corpo libero in poliuretano e moquette, spessore mm 25, dimensioni mt 25x1
Rollable gymnastic exercises mat, polyurethane foam covered with carpet, thickness 25 mm, dimensions 25x1 mt

S00220

Tappeto arrotolabile per pedana corpo libero in poliuretano e moquette, spessore mm 35, dimensioni mt 15x2
Rollable gymnastic exercises mat, polyurethane foam covered with carpet, thickness 35 mm, dimensions 15x2 mt

S00221

Rotolo di Velcro di colore rosso per unione tappeto arrotolabile, altezza cm 10, lunghezza mt 20
Roll of red Velcro for connecting rollable gymnastic mats, height 10 cm, length 20 mt

5

**Pedane elastiche,
pedane corpo libero
Springboards,
gymnastic floors**

S00202

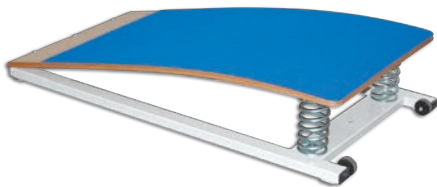
**S00202**

Pedana elastica a molle di acciaio, piano di battuta ricoperto di moquette, telaio con ruote

Springboard equipped with 2 steel springs, carpet covered surface, ground frame with transport wheels

S00204

**S00204**

Pedana elastica con piano di battuta di legno
Springboard with wooden surface

S00206



6

Sbarre orizzontali per volteggi - *Horizontal high bars***S00252**

Sbarra orizzontale per volteggi regolabile in altezza, fissaggio a terra con tiranti

Horizontal high bar suitable for vaulting, adjustable in height, to be fixed with cables



S00254

S00254

Sbarra orizzontale per volteggi omologata FIG per competizioni, regolabile in altezza, fissaggio a terra con tiranti

Horizontal high bar suitable for vaulting FIG approved for competition, adjustable in height, to be fixed with cables

7

Appoggi e ceppi - *Baumann supports and blocks*

S00302



S00304

S00302

Coppia appoggi Baumann di legno massiccio verniciato

Pair of Baumann supports in varnished wood

S00304

Coppia ceppi Baumann di legno massiccio verniciato

Pair of Baumann blocks in varnished wood

S00306

**S00306**

Mensola in acciaio verniciato porta ceppi e appoggi da fissare a parete

Varnished steel wall rack for Baumann supports and blocks



S00352

S00352

Armadio porta attrezzi di lamiera verniciata ad ante battenti con vano interno porta valori, dimensioni cm 100X45X200

Equipment locker made from varnished sheet steel with shelves and lockable compartment for valuables inside, dimensions 100x45x200 cm



S00354

S00354

Armadio porta attrezzi di lamiera verniciata ad ante battenti con 4 ripiani, dimensioni cm 100x45x200

Equipment locker made from varnished sheet steel with 4 shelves inside, dimensions 100x45x200 cm



S00356

S00356

Armadio porta attrezzi di lamiera verniciata ad ante scorrevoli con 4 ripiani, dimensioni cm 120x45x200

Equipment locker made from varnished sheet steel with 4 shelves inside and sliding doors, dimensions 120x45x200 cm

S00358

**S00358**

Armadio porta attrezzi con pareti in rete metallica zincata e 2 ripiani, dimensioni cm 155x75x160 mobile su ruote, smontabile

Equipment trolley mobile on wheels, made of galvanized steel mesh walls with 2 shelves, dimensions 155x75x160 cm, can be dismantled



S00360

S00360

Mobile porta attrezzi ginnici a 3 ripiani, in acciaio verniciato

Varnished steel gymnastic equipment trolley with 3 shelves



S00362

**S00362**

Mobile porta attrezzi ginnici a 3 ripiani, in acciaio verniciato, mobile su ruote

Varnished steel gymnastic equipment trolley with 3 shelves, mobile on wheels



S00366

S00366

Carrello porta attrezzi di legno massiccio a 3 ripiani, mobile su ruote girevoli, completo di maniglie, dimensioni totali cm 95x70x100

Wooden equipment trolley with 3 shelves, mobile on pivoting wheels, complete with handles, total dimension 95x70x100 cm

9

Bastoni - Gymnastic sticks**S00402**

Bastone di legno, diametro mm 24, lunghezza cm 80

Wooden gymnastic stick, diameter 24 mm, length 80 cm

S00404

Bastone di legno, diametro mm 24, lunghezza cm 90

Wooden gymnastic stick, diameter 24 mm, length 90 cm

S00405

Bastone di legno, diametro mm 24, lunghezza cm 100

Wooden gymnastic stick, diameter 24 mm, length 100 cm

S00406

Bastone di legno, diametro mm 24, lunghezza cm 120

Wooden gymnastic stick, diameter 24 mm, length 120 cm

S00407

Bastone di legno, diametro mm 24, lunghezza cm 150

Wooden gymnastic stick, diameter 24 mm, length 150 cm

**S00408**

Bastone di plastica, diametro mm 25, lunghezza cm 80

Plastic gymnastic stick, diameter 25 mm, length 80 cm

S00411

Bastone di plastica, diametro mm 25, lunghezza cm 100

Plastic gymnastic stick, diameter 25 mm, length 100 cm

S00412

Bastone di plastica, diametro mm 25, lunghezza cm 120

Plastic gymnastic stick, diameter 25 mm, length 120 cm

S00414

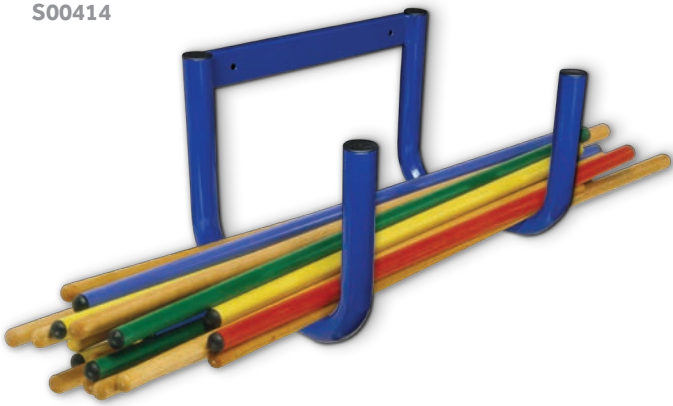
**S00414**

Mensola in acciaio verniciato porta bastoni da fissare a parete

Varnished steel wall rack for gymnastic sticks

10

Cerchi Gymnastic hoops

**S00452**

Cerchio di nylon colorato, sezione piatta, diametro cm 40

Coloured nylon hoop, flat section, diameter 40 cm

S00454

Cerchio di nylon colorato, sezione piatta, diametro cm 50

Coloured nylon hoop, flat section, diameter 50 cm

S00456

Cerchio di nylon colorato, sezione piatta, diametro cm 60

Coloured nylon hoop, flat section, diameter 60 cm

S00458

Cerchio di nylon colorato, sezione piatta, diametro cm 70

Coloured nylon hoop, flat section, diameter 70 cm

S00460

Cerchio di nylon colorato, sezione piatta, diametro cm 80

Coloured nylon hoop, flat section, diameter 80 cm

S00464

Cerchio di plastica colorato, sezione tonda, diametro cm 60

Coloured plastic tubular hoop, round section, diameter 60 cm

S00466

Cerchio di plastica colorato, sezione tonda, diametro cm 70

Coloured plastic tubular hoop, round section, diameter 70 cm

S00468

Cerchio di plastica colorato, sezione tonda, diametro cm 80

Coloured plastic tubular hoop, round section, diameter 80 cm

S00470

Cerchio di plastica colorato, sezione tonda, diametro cm 90

Coloured plastic tubular hoop, round section, diameter 90 cm

S00472

**S00472**

Mensola in acciaio verniciato porta cerchi da fissare a parete

Varnished steel wall rack for gymnastic hoops

11

Clavette Gymnastic clubs



S00502

S00502

Coppia clavette di legno verniciato, altezza cm 31
Pair of varnished wooden clubs, height 31 cm

S00504

Coppia clavette di legno verniciato, altezza cm 35
Pair of varnished wooden clubs, height 35 cm

S00506

Coppia clavette di legno verniciato, altezza cm 40
Pair of varnished wooden clubs, height 40 cm

S00510

Coppia clavette di nylon colorato, secondo norme FIG
Pair of coloured nylon clubs, in accordance to FIG rules

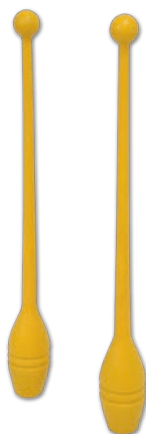

S00510



S00512

S00512

Mensola in acciaio verniciato porta clavette da fissare a parete
Varnished steel wall rack for gymnastic clubs

12

Funi, funicelle Ropes

19 / 210



S00552

S00552

Fune per tiro alla fune, con indicazioni colorate, lunghezza mt 15
Tug of war rope, marked sections, length 15 mt

S00554

Fune per tiro alla fune, con indicazioni colorate, lunghezza mt 20
Tug of war rope, marked sections, length 20 mt

S00556

Fune per tiro alla fune, con indicazioni colorate, lunghezza mt 25
Tug of war rope, marked sections, length 25 mt

S00558

Funicella con ingrossamento centrale
Hemp skipping rope with thick reinforced centrepiece



S00558



S00560

S00560

Funicella con ingrossamento centrale e manopole
Hemp skipping rope with thick reinforced centrepiece and handles

S00562

Funicella, di cotone colorato, piombata
Coloured center leaded cotton skipping rope



S00562

S00564



S00564

Mensola in acciaio verniciato porta funicelle da fissare a parete
Varnished steel wall rack for skipping ropes

NOTE

Materassi con rivestimento composito a prevalenza di PVC "Carbon", resistente alla trazione, alla rottura ed alla lacerazione secondo la norma UNI4818, resistente al fuoco in classe 2 secondo la norma UNI9475, con trattamento antibatterico. Dotati di maniglie in PVC, zip e sfiati (per materassi con spessore superiore a cm 10). Interno in gomma espansa con densità "d." variabile in base al diverso spessore del materasso (densità 80 per materassi con spessore cm 5, densità 60 per materassi con spessore cm 10, densità 16 per materassi con spessore superiore a cm 10). Per densità si intende il rapporto kg/m³.

Gym mats are covered by a composite PVC fabric "Carbon", resistant to traction, breakage and laceration complying to UNI4818 standard, and fireproof resistant class 2 complying to UNI9475 standard, anti-bacterial treated. Equipped with PVC handles, zip and breather holes (on mats with thickness over 10 cm). The interior is made of expanded foam with different densities "d." depending on the sheet's thickness (density 80 for mats with thickness 5 cm, density 60 for mats with thickness 10 cm, density 16 for mats with thickness over 10 cm). Density corresponds to ratio kg/m³.

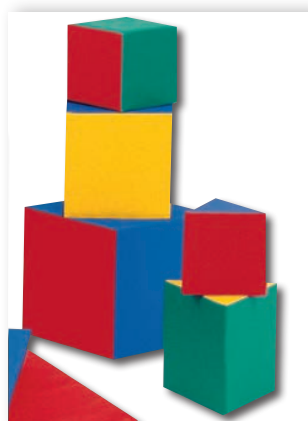

Rivestimento disponibile anche di colore **giallo**, **verde** e **rosso**.

PVC fabric also available in **yellow**, **green** and **red**.

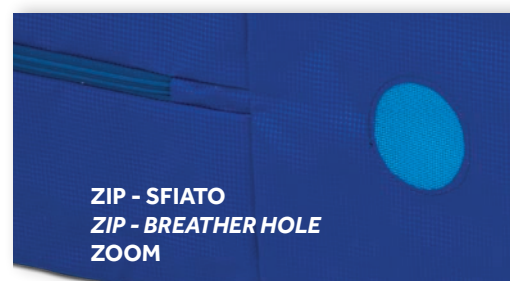

S00604 - S00606

**S00604**

Materasso d. 80, cm 200x100x5
Mat d. 80, 200x100x5 cm

S00608 - S00610

**S00608**

Materasso d. 60, cm 200x100x10
Mat d. 60, 200x100x10 cm

S00606

Materasso d. 80, cm 200x100x5 fondo antiscivolo
Mat d. 80, 200x100x5 cm, slip-proof bottom side

S00610

Materasso d. 60, cm 200x100x10 fondo antiscivolo
Mat d. 60, 200x100x10 cm, slip-proof bottom side

S00612- S00614

**S00612**

Materasso cm 200x100x20
Soft landing mat 200x100x20 cm

S00614

Materasso cm 200x100x20 fondo antiscivolo
Soft landing mat 200x100x20 cm, slip-proof bottom side

S00616

Materasso cm 200x100x30
Soft landing mat 200x100x30 cm

S00618

Materasso cm 200x100x30 fondo antiscivolo
Soft landing mat 200x100x30 cm, slip-proof bottom side

S00620- S00622

**S00620**

Materasso cm 200x100x40
Soft landing mat 200x100x40 cm

S00622

Materasso cm 200x100x40 fondo antiscivolo
Soft landing mat 200x100x40 cm, slip-proof bottom side

S00624

Materasso cm 200x100x50
Soft landing mat 200x100x50 cm

S00626

Materasso cm 200x100x50 fondo antiscivolo
Soft landing mat 200x100x50 cm, slip-proof bottom side

S00628

Materasso cm 200x200x40
Soft landing mat 200x200x40 cm

S00630

Materasso cm 200x200x40 fondo antiscivolo
Soft landing mat 200x200x40 cm, slip-proof bottom side

S00632

Materasso cm 200x200x45
Soft landing mat 200x200x45 cm

S00634

Materasso cm 200x200x45 fondo antiscivolo
Soft landing mat 200x200x45 cm, slip-proof bottom side

S00636

Materasso cm 200x200x50
Soft landing mat 200x200x50 cm

S00638

Materasso cm 200x200x50 fondo antiscivolo
Soft landing mat 200x200x50 cm, slip-proof bottom side

S00640

Materasso cm 200x300x30
Soft landing mat 200x300x30 cm

S00642

Materasso cm 200x300x30 fondo antiscivolo
Soft landing mat 200x300x30 cm, slip-proof bottom side

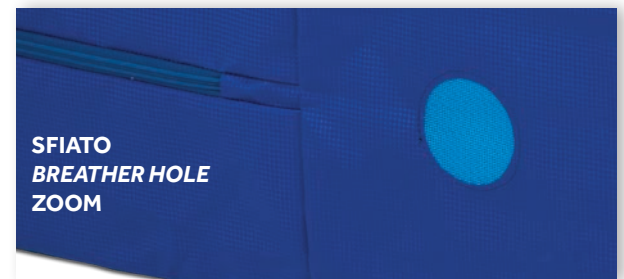
**S00644**

Materasso cm 200x300x40
Soft landing mat 200x300x40 cm

S00646

Materasso cm 200x300x40 fondo antiscivolo
Soft landing mat 200x300x40 cm, slip-proof bottom side

S00648

Materasso cm 200x300x50
Soft landing mat 200x300x50 cm

S00650

Materasso cm 200x300x50 fondo antiscivolo
Soft landing mat 200x300x50 cm, slip-proof bottom side

Materassi realizzabili anche con misure diverse da quelle elencate e, a richiesta, rivestimento disponibile anche di colore **giallo, **verde** e **rosso**.**

Gym mats can be produced with different dimensions on demand. PVC fabric also available in **yellow, **green** and **red** colors.**

NOTE

S00652 - S00654

**S00652**

Materasso cm 400x200x40, tipo Manoni
Manoni type landing mat 400x200x40 cm

S00654

Materasso cm 400x200x40, tipo Manoni, fondo antiscivolo
Manoni type landing mat 400x200x40 cm, slip-proof bottom side

S00656

Materasso cm 400x200x45, tipo Manoni
Manoni type landing mat 400x200x45 cm

S00658

Materasso cm 400x200x45, tipo Manoni, fondo antiscivolo
Manoni type landing mat 400x200x45 cm, slip-proof bottom side

S00660

Materasso cm 400x200x50, tipo Manoni
Manoni type landing mat 400x200x50 cm

S00662

Materasso cm 400x200x50, tipo Manoni, fondo antiscivolo
Manoni type landing mat 400x200x50 cm, slip-proof bottom side

S00664

Materasso cm 200x200x20 pieghevole a formare un materasso cm 200x100x40
Book closing landing mat 200x200x20 cm becoming 200x100x40 cm

S00666

Materasso cm 200x200x20 pieghevole a formare un materasso cm 200x100x40, fondo antiscivolo
Book closing landing mat 200x200x20 cm becoming 200x100x40 cm, slip-proof bottom side



S00652 - S00654 ZOOM

S00668

Materasso cm 400x200x20 pieghevole a formare un materasso cm 200x200x40
Book closing landing mat 400x200x20 cm becoming 200x200x40 cm

S00670

Materasso cm 400x200x20 pieghevole a formare un materasso cm 200x200x40, fondo antiscivolo
Book closing landing mat 400x200x20 cm becoming 200x200x40 cm, slip-proof bottom side

S00668 - S00670



S00668 - S00670

S00672

Fodera di ricambio per materassi dotata di sfiati, maniglie e zip

Spare cover for mats equipped with breather holes, handles and zip

S00674

Fodera di ricambio per materassi dotata di sfiati, maniglie e zip, con fondo antiscivolo

Spare cover for mats equipped with breather holes, handles and zip, slip-proof bottom side

S00676

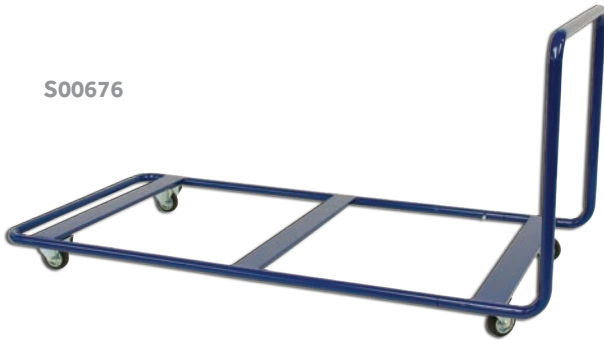
**S00676**

Carrello porta materassi in acciaio verniciato, cm 200x100, mobile su ruote

Varnished steel mat trolley, 200x100 cm, mobile on wheels

S00678

Carrello verticale porta materassi in acciaio verniciato, mobile su ruote

Vertical mat trolley made in varnished steel, mobile on wheels

S00678

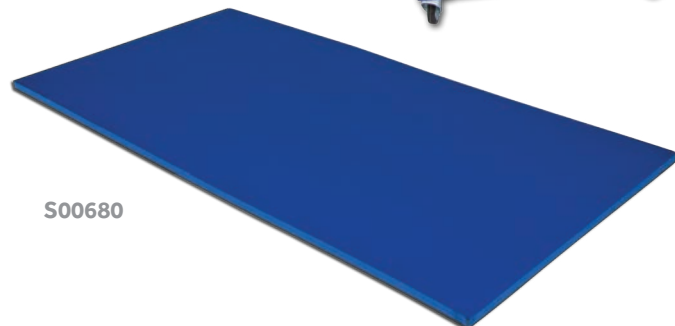

S00680

**S00680**

Tappeto GYM MAT in polietilene a cellula chiusa, fondo antiscivolo, cm 200x100x3

Gym Mat 200x100x3 cm, high density polyethylene, slip-proof bottom side

S00681

Tappeto GYM MAT in polietilene a cellula chiusa, fondo antiscivolo, cm 200x100x4

Gym Mat 200x100x4 cm, high density polyethylene, slip-proof bottom side



S00682

S00682

Tappeto GYM MAT in polietilene a cellula chiusa, fondo antiscivolo, cm 200x100x5

Gym Mat 200x100x5 cm, high density polyethylene, slip-proof bottom side

S00683

Tappeto GYM MAT in polietilene a cellula chiusa, fondo antiscivolo, cm 200x100x6

Gym Mat 200x100x6 cm, high density polyethylene, slip-proof bottom side

**S00684**

Tappeto MAT GOLD K14, in poliuretano, cm 200x100x3

Mat Gold K14 polyurethane mat 200x100x3 cm

S00685

Tappeto MAT GOLD K16, in poliuretano, cm 200x100x4

Mat Gold K16 polyurethane mat 200x100x4 cm

S00686

Tappeto MAT GOLD K20, in poliuretano, cm 200x100x5

Mat Gold K20 polyurethane mat 200x100x5 cm

S00687

Tappeto MAT GOLD K24, in poliuretano, cm 200x100x6

Mat Gold K24 polyurethane mat 200x100x6 cm

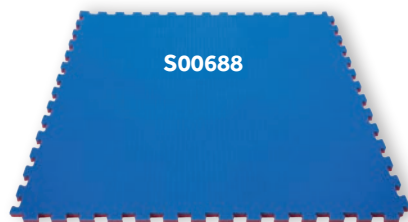

S00688

S00688**NEW**

Tappeto per karate ad incastro omologato WKF, in polietilene cm 100x100x2

Polyethylene WKF approved karate mat 100x100x2 cm, attachable on the 4 sides

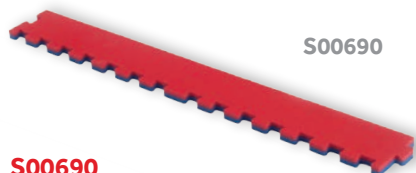

S00690

S00690

Bordo tappeto karate in polietilene, elemento da cm 100

Polyethylene lateral element for karate area, length 100 cm

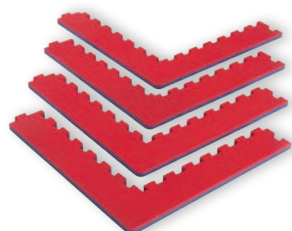
**S00692**

Kit angoli tappeto karate, in polietilene
Set of polyethylene corner elements for karate area



S00694

S00694**NEW**

Tatami per judo ad incastro in polietilene, cm 100x100x4

Polyethylene tatami judo mat, 100x100x4 cm, attachable on the 4 sides

S00696

Bordo tatami judo in polietilene, elemento da cm 100

Polyethylene lateral element for judo area, length 100 cm

S00698

Kit angoli tappeto judo in polietilene
Set of polyethylene corner elements for judo area

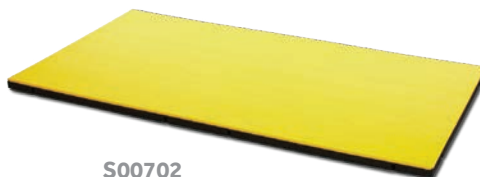

S00702

**S00702****NEW**

Tatami per judo in polietilene, cm 200x100x5, omologato IJF, con sistema di aggancio a scomparsa

Polyethylene tatami judo mat, 200x100x5 cm, IJF approved, with hidden attaching solution



S00704 - S00706 - S00708

S00704

Tappeto lotta in agglomerato d. 150, cm 200x100x5, omologato FILA

Wrestling mat d. 150, 200x100x5 cm, FILA approved

S00706

Tappeto lotta in agglomerato d. 150, cm 200x100x5, fondo antiscivolo, omologato FILA

Wrestling mat d. 150, 200x100x5 cm, slip-proof base, FILA approved

S00708

Telo di copertura per tappeto lotta, mt 12x12

Mat cover for wrestling area, dimensions 12x12 mt

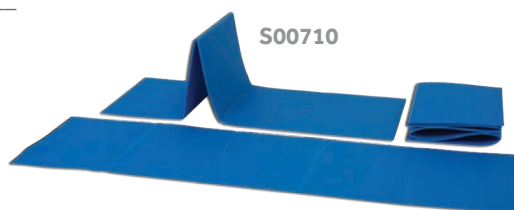

S00710

S00710

Stuoia pieghevole gofrata cm 180x50x0,8 in polietilene

Polyethylene folding mat for fitness exercises, 180x50x0.8 cm



S00712

S00712

Stuoia arrotolabile colorata, cm 150x70x1, fondo antiscivolo

Coloured rollable mat for fitness exercises 150x70x1 cm, slip-proof bottom side



S00714

S00714

Materassina individuale pieghevole rivestita di vinile, cm 150x60x1

Individual folding exercise mat, covered with vinyl material, 150x60x1 cm

S00716

Materassina individuale pieghevole rivestita di vinile, cm 180x60x4

Individual folding exercise mat, covered with vinyl material, 180x60x4 cm



S00718

S00718

Materasso jump test per attività di coordinazione al salto

Jump test mat for school jump practice

**S00752**

Palco di salita 2 pertiche di acciaio, 2 funi di canapa, 2 scale a corda, altezza mt 5
Climbing apparatus 2 steel poles, 2 hemp ropes, 2 rope ladders, height 5 mt

S00754

Palco di salita 2 pertiche di acciaio, 2 funi di canapa, 2 scale a corda, altezza mt 6
Climbing apparatus 2 steel poles, 2 hemp ropes, 2 rope ladders, height 6 mt

S00756

Palco di salita 2 pertiche di acciaio, 2 funi di canapa, altezza mt 5
Climbing apparatus 2 steel poles, 2 hemp ropes, height 5 mt

S00758

Palco di salita 2 pertiche di acciaio, 2 funi di canapa, altezza mt 6
Climbing apparatus 2 steel poles, 2 hemp ropes, height 6 mt

S00760

Palco di salita 2 pertiche di legno, 2 funi di canapa, altezza mt 5
Climbing apparatus 2 wooden poles, 2 hemp ropes, height 5 mt

S00762

Palco di salita 2 pertiche di legno, 2 funi di canapa, altezza mt 6
Climbing apparatus 2 wooden poles, 2 hemp ropes, height 6 mt

S00764

Palco di salita 3 pertiche di acciaio, 3 funi di canapa, altezza mt 5
Climbing apparatus 3 steel poles, 3 hemp ropes, height 5 mt

S00766

Palco di salita 3 pertiche di acciaio, 3 funi di canapa, altezza mt 6
Climbing apparatus 3 steel poles, 3 hemp ropes, height 6 mt

S00768

Palco di salita 3 pertiche di legno, 3 funi di canapa, altezza mt 5
Climbing apparatus 3 wooden poles, 3 hemp ropes, height 5 mt

S00770

Palco di salita 3 pertiche di legno, 3 funi di canapa, altezza mt 6
Climbing apparatus 3 wooden poles, 3 hemp ropes, height 6 mt

S00772

Fune per salita, lunghezza mt 5
Climbing hemp rope, length 5 mt

S00774

Fune per salita, lunghezza mt 6
Climbing hemp rope, length 6 mt

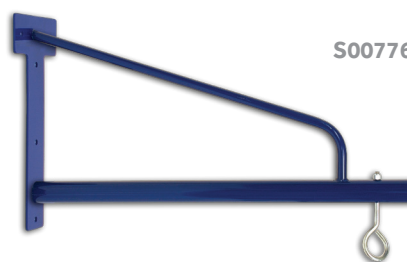
**S00776**

Mensola per fune completa di gancio per attacco
Varnished steel wall rack for climbing rope

Funi, pertiche e scale a corda possono essere fissate a muro tramite sistema di sospensione S00792.

Climbing ropes, poles and rope ladders can be installed to the wall through apparatus S00792.

NOTE

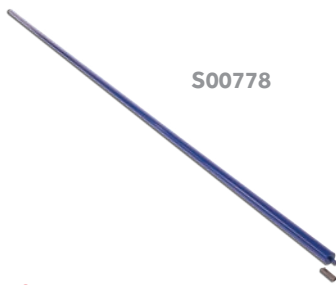

S00778

S00778

Pertica di acciaio, altezza mt 5
Varnished tubular steel climbing pole 5 mt long



S00780 - ZOOM

S00780

Pertica di acciaio, altezza mt 6
Varnished tubular steel climbing pole 6 mt long



S00782

S00782

Pertica di legno, altezza mt 5
Wooden climbing pole 5 mt long



S00784 - ZOOM

S00784

Pertica di legno, altezza mt 6
Wooden climbing pole 6 mt long



S00786

S00786

Mensola per pertica completa di gancio per attacco
Varnished steel wall rack for climbing pole



S00788

S00788

Scala a corda di canapa con pioli di faggio, lunghezza mt 5
Hemp rope ladder, 5 mt long with solid wooden rungs

S00790

Scala a corda di canapa con pioli di faggio, lunghezza mt 6
Hemp rope ladder, 6 mt long with solid wooden rungs



ZOOM

S00792

S00792

Sistema di sospensione e accostamento a parete per attrezzi da arrampicata, struttura variabile in base al numero di funi, pertiche o scale supportate
Apparatus for supporting and sliding to the wall climbing equipment, to be dimensioned depending on the number of climbing ropes, poles or ladders connected



S00796

S00796

Sistema di arrampicata da fissare a muro composto di nr 12 pannelli di legno con appigli in resina su telaio in acciaio
Practice climbing area made of 12 wooden panels with resin handholds mounted onto steel frame to be fixed to the wall

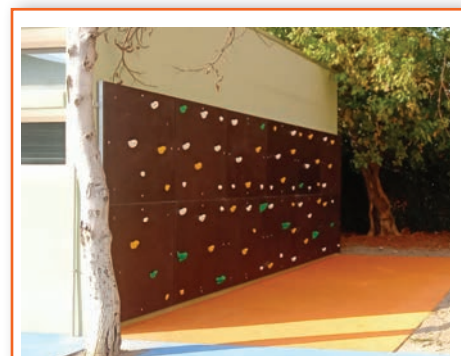

Sistema di arrampicata S00796 disponibile, su richiesta, anche in versione per uso esterno.

Practice climbing area S00796 available, on demand, on outdoor use version.

NOTE

**S00852**

Palla medica rigonfiabile di gomma, peso kg 1
Rubber medicine ball with needle valve, weight 1 kg

**S00854**

Palla medica rigonfiabile di gomma, peso kg 1,5
Rubber medicine ball with needle valve, weight 1.5 kg

**S00856**

Palla medica rigonfiabile di gomma, peso kg 2
Rubber medicine ball with needle valve, weight 2 kg

**S00858**

Palla medica rigonfiabile di gomma, peso kg 3
Rubber medicine ball with needle valve, weight 3 kg

**S00860**

Palla medica rigonfiabile di gomma, peso kg 4
Rubber medicine ball with needle valve, weight 4 kg

**S00862**

Palla medica rigonfiabile di gomma, peso kg 5
Rubber medicine ball with needle valve, weight 5 kg

**S00864**

Palla medica rigonfiabile di gomma, peso kg 6
Rubber medicine ball with needle valve, weight 6 kg

**S00866**

Palla medica rigonfiabile di gomma, peso kg 7
Rubber medicine ball with needle valve, weight 7 kg

**S00868**

Palla medica rigonfiabile di gomma, attrezzata, peso kg 1
Rubber medicine ball with needle valve and rope, weight 1 kg

**S00870**

Palla medica rigonfiabile di gomma, attrezzata, peso kg 1,5
Rubber medicine ball with needle valve and rope, weight 1.5 kg

**S00872**

Palla medica rigonfiabile di gomma, attrezzata, peso kg 2
Rubber medicine ball with needle valve and rope, weight 2 kg

**S00874**

Palla medica rigonfiabile di gomma, attrezzata, peso kg 3
Rubber medicine ball with needle valve and rope, weight 3 kg

**S00876**

Palla medica rigonfiabile di gomma, attrezzata, peso kg 4
Rubber medicine ball with needle valve and rope, weight 4 kg

**S00878**

Palla medica rigonfiabile di gomma, attrezzata, peso kg 5
Rubber medicine ball with needle valve and rope, weight 5 kg

**S00880**

Palla medica rigonfiabile di gomma, attrezzata, peso kg 6
Rubber medicine ball with needle valve and rope, weight 6 kg

**S00882**

Palla medica rigonfiabile di gomma, attrezzata, peso kg 7
Rubber medicine ball with needle valve and rope, weight 7 kg

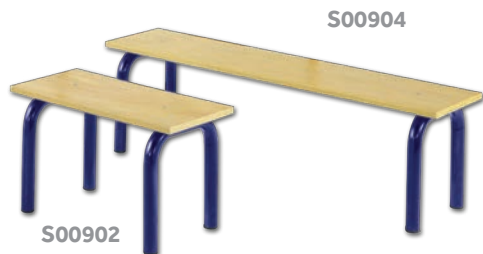
**S00902**

Panca per esercizi alla spalliera, piano in legno, lunghezza cm 60

Bench suitable for wall bar exercises, wooden surface, length 60 cm

S00904

Panca per esercizi alla spalliera, piano in legno, lunghezza cm 120

Bench suitable for wall bar exercises, wooden surface, length 120 cm

**S00906**

Panca per addominali agganciabile alla spalliera, piano in legno

Incline board for abdominal exercises on wall bar, wooden surface

S00908

Panca per addominali agganciabile alla spalliera, piano imbottito e rivestito

Incline board for abdominal exercises on wall bar, padded and covered surface

**S00914**

Panca svedese con telaio in acciaio e asse di equilibrio in legno, lunghezza mt 3

Swedish gym bench with steel structure and wooden balance beam, 3 mt long



S00914 - ZOOM

S00916

Panca svedese con telaio in acciaio senza asse di equilibrio, lunghezza mt 3

Swedish gym bench with steel structure without balance beam, 3 mt long

**S00918**

Panca svedese interamente di legno massiccio, lunghezza mt 2

Swedish gym bench entirely made of wood, 2 mt long

S00918
S00920
ZOOM**S00920**

Panca svedese interamente di legno massiccio, lunghezza mt 3,5

Swedish gym bench entirely made of wood, 3.5 mt long

NOTE

Panca svedese **S00920** realizzabile anche con lunghezze diverse.

Swedish gym bench S00920 can be produced with different length.

S00952

Plinto con gambe di acciaio regolabili in altezza, piano imbottito e rivestito di cuoio naturale

Gymnastic vaulting table, steel adjustable legs, wooden surface padded and covered with natural leather



S00954

S00956

Plinto trapezoidale di legno a 6 cassoni, piano imbottito e rivestito di cuoio naturale

Trapezoidal wooden vaulting box with 6 sections, padded and natural leather covered surface



S00958

S00960

Plinto verticale di legno a 5 cassoni con dispositivo di trasporto su ruote, piano imbottito e rivestito di cuoio sintetico

Vertical wooden vaulting box with 5 sections, padded and synthetic leather covered surface, transport device on wheels included



S00962

S00954

Plinto con gambe di acciaio regolabili in altezza, piano imbottito e rivestito di cuoio sintetico

Gymnastic vaulting table, steel adjustable legs, wooden surface padded and covered with synthetic leather

S00958

Plinto trapezoidale di legno a 6 cassoni, piano imbottito e rivestito di cuoio sintetico

Trapezoidal wooden vaulting box with 6 sections, padded and synthetic leather covered surface

S00962

Plinto verticale di legno a 6 cassoni con dispositivo di trasporto su ruote, piano imbottito e rivestito di cuoio sintetico

Vertical wooden vaulting box with 6 sections, padded and synthetic leather covered surface, transport device on wheels included



S01004

S01002

Quadro svedese oscillante a 16 fori (4X4 h), incluse mensole a muro
Swedish runged swinging wall bar with 16 holes (4X4 h), included wall racks

S01004

Quadro svedese oscillante a 24 fori (4X6 h), incluse mensole a muro
Swedish runged swinging wall bar with 24 holes (4X6 h), included wall racks

S01006

Quadro svedese oscillante a 36 fori (6X6 h), incluse mensole a muro
Swedish runged swinging wall bar with 36 holes (6X6 h), included wall racks

19

Scale Wall ladders



S01052

Scala ortopedica dritta da fissare a parete, montanti di acciaio e pioli di faggio

Wall mounted straight ladder, steel columns and wooden rungs

S01054

Scala ortopedica curva da fissare a parete, montanti di acciaio e pioli di faggio

Wall mounted curved ladder, steel columns and wooden rungs



S01056

Scala ortopedica dritta da fissare a parete, montanti e pioli di faggio

Wall mounted straight ladder, entirely made in wood

S01058

Scala ortopedica curva da fissare a parete, montanti e pioli di faggio

Wall mounted curved ladder, entirely made in wood



S01060

Scala orizzontale da fissare a parete, lunghezza mt 5, graduabile in altezza

Wall mounted wooden horizontal ladder on steel frame, adjustable height, length 5 mt



S01062

Scala orizzontale trasportabile, lunghezza mt 5, graduabile in altezza

Transportable wooden horizontal ladder on steel supports, adjustable height, length 5 mt

20

Spalliere e articoli in legno - Wall bars and wooden equipment



S01102

Spalliera svedese di legno a 1 campata, cm 90x250

Swedish wooden wall bar at 1 span, 90x250 cm

S01104

Spalliera svedese di legno a 2 campate, cm 180x250

Swedish wooden wall bar at 2 spans, 180x250 cm



S01108

Spalliera svedese di legno a 2 campate, cm 180x250, modello smontato

Swedish wooden wall bar at 2 spans, 180x250 cm, dismantled model

**S01110**

Spalliera svedese di legno a 1 campata a norme DIN, cm 90x260
 Swedish wooden wall bar at 1 span in accordance to DIN norm, 90x260 cm

S01112

Spalliera svedese di legno a 2 campate a norme DIN, cm 180x260
 Swedish wooden wall bar at 2 spans, in accordance to DIN norm, 180x260 cm

S01114

Poggiaschiena curvo, imbottito e rivestito, agganciabile alla spalliera
 Curved padded and covered backrest to be attached to wall bar

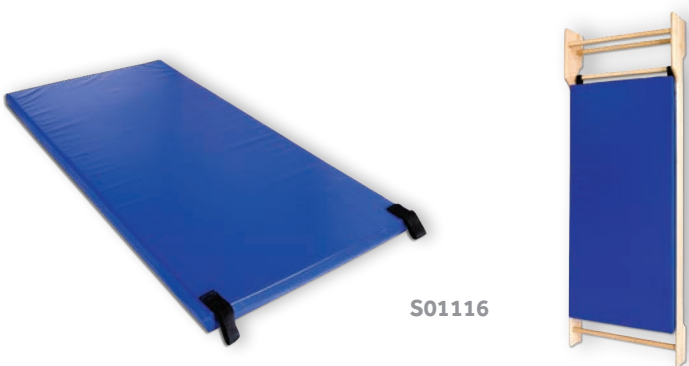
**S01116**

Materasso per spalliera cm 180x85 con bandelle di Velcro
 Wall bar soft mat 180x85 cm with Velcro strips

S01118

Piolo di ricambio per spalliera, lunghezza cm 90
 Spare wooden rung for wall bar, length 90 cm

S01120

Piolo di ricambio per spalliera, lunghezza cm 180
 Spare wooden rung for wall bar, length 180 cm



S01130

31 / 210

S01130

Scivolo in legno per spalliera, larghezza cm 45, lunghezza cm 240
 Wooden slide hanging on wall bar, width 45 cm, length 240 cm

S01132

Scaletta zig-zag in legno per spalliera, larghezza cm 35, lunghezza cm 250
 Wooden zigzag ladder hanging on wall bar, width 35 cm, length 250 cm



S01132



ZOOM

S01134

S01134

Asse di equilibrio in legno con scaletta triangolare, larghezza cm 10, lunghezza cm 250. Agganciabile anche a spalliera
 Wooden balancing beam on triangle step module, width 10 cm, length 250 cm. Can be connected to wall bar

**S01136**

Panchetta di equilibrio in legno con scaletta triangolare, larghezza cm 18, lunghezza cm 250. Agganciabile anche a spalliera

Wooden balancing bench on triangle step module, width 18 cm, length 250 cm. Can be connected to wall bar

**S01142****S01142**

Set di 5 sgabelli in legno con dimensioni differenti per esercizi ginnici e fitness

Set of 5 wooden gymnastic and fitness stools in different sizes

S01138

Scaletta "gallina" in legno per spalliera, larghezza cm 18, lunghezza cm 250

Wooden hen bench hanging on wall bar, width 18 cm, length 250 cm

**S01138****S01144****S01144**

Scaletta semicircolare in legno bassa, dimensioni cm 90x60x30

Small semi-circular wooden ladder, dimensions 90x60x30 cm

**S01140****S01140**

Set di 10 panchette in legno con lunghezze differenti per esercizi ginnici e fitness

Set of 10 wooden small gymnastic and fitness benches in different lengths

**S01146****S01146**

Scaletta semicircolare in legno alta, dimensioni cm 100x60x50

Large semi-circular wooden ladder, dimensions 100x60x50 cm

**S01144 + S01146**

S01148

**S01148**

Percorso di equilibrio in legno, componibile attraverso 5 supporti e 5 assi

Modular wooden balance path composed of 5 blocks and 5 axes

21

Trampolini - Trampolines

S01152

S01152

Mini trampolino, diametro cm 90, altezza cm 20

Mini trampoline, round shape diameter 90 cm, height 20 cm



S01154

S01154

Trampolino elastico con struttura ad altezza ed inclinazione regolabili, in acciaio verniciato, dimensioni cm 125x125, completo di protezione laterale

Elastic trampoline made of varnished steel structure with adjustable height and inclination, dimensions 125x125 cm, including side protection pad

S01156

**S01156**

Protezione laterale per trampolino S01154

Side protection pad for trampoline S01154



S01158

S01158

Trampolino elastico Master School per allenamento ed attività scolastica, area di salto cm 366x183, telo in poliestere

Master School elastic trampoline for practice, polyester jumping bed 366x183 cm



S01160

S01160

Trampolino Ultimate omologato FIG per competizioni, area di salto cm 426x213, telo in nylon

Ultimate trampoline, FIG approved for competition, nylon jumping bed 426x213 cm

22

Palle e accessori per ginnastica ritmica - *Balls and accessories for rhythmic gymnastic*

S01202

S01202

Palla per ginnastica ritmica di gomma, peso gr 280
Rubber rhythmic gymnastic ball, weight 280 gr

S01204

Palla per ginnastica ritmica di gomma, peso gr 400
Rubber rhythmic gymnastic ball, weight 400 gr



S01206

S01206

Palla per ginnastica ritmica in materiale siliconico, peso gr 400, omologata FIG
Rubber rhythmic gymnastic ball made in silicone-base compound, weight 400 gr, FIG approved



S01208

S01208

Palla per ginnastica ritmica di caucciù naturale Sasaki, omologata FIG per competizioni, monocoloro
Natural rubber rhythmic gymnastic ball Sasaki, FIG approved for competitions, monochrome

S01210

**S01210**

Nastro per ginnastica ritmica, lunghezza mt 6
Coloured rhythmic gymnastic ribbon, length 6 mt



S01212

S01212

Avvolgitore nastro per ginnastica ritmica
Plastic device for wrapping up the rhythmic gymnastic ribbon



S01214

S01214

Nastro per ginnastica ritmica Sasaki, con bastoncino, omologato FIG per competizioni
Coloured rhythmic gymnastic ribbon Sasaki, complete of stick, FIG approved for competitions



S01216

S01216

Funicella di cotone colorato, piombata, per ginnastica ritmica
Coloured rhythmic gymnastic center leaded cotton rope



S01218

S01218

Funicella per ginnastica ritmica Sasaki, in poliestere, omologata FIG per competizioni
Coloured rhythmic gymnastic rope Sasaki, made of polyester, FIG approved for competitions

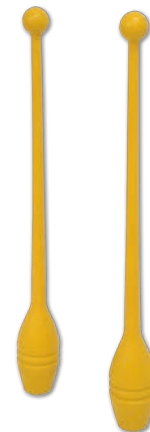
**S01220**

Coppia clavette di nylon per ginnastica ritmica secondo norme FIG
Pair of coloured rhythmic gymnastic nylon clubs in accordance to FIG norms

Palle **S01208** disponibili in varie combinazioni cromatiche, per informazioni: info@sportsystem.it

NOTE

Balls S01208 available in different chromatic combinations, for more info: info@sportsystem.it





S01222

S01222

Coppia clavette di plastica per ginnastica ritmica Sasaki, omologate FIG per competizioni
Pair of coloured rhythmic gymnastic plastic clubs Sasaki, FIG approved for competitions



S01224

S01224

Cerchio di PVC colorato, diametro cm 80 per allenamento ginnastica ritmica
Coloured plastic tubular hoop, diameter 80 cm for practicing rhythmic gymnastic

S01226

Cerchio di PVC colorato, diametro cm 90 per allenamento ginnastica ritmica
Coloured plastic tubular hoop, diameter 90 cm for practicing rhythmic gymnastic

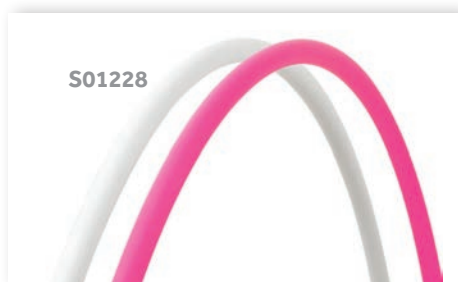

S01228

S01228

Cerchio di PVC colorato per ginnastica ritmica Sasaki, omologato FIG per competizioni, diametro cm 85
Coloured rhythmic gymnastic plastic tubular hoop Sasaki, FIG approved for competitions, diameter 85 cm

23

**Accessori per
ginnastica aerobica**
**Accessories for
aerobic gymnastic**



S01302

S01302

Bande elastiche colorate per aerobica
Aerobic coloured elastic band



S01306

S01306

Elastico tubing per esercizi di potenziamento, resistenza media
Elastic tubing, medium resistance



S01310

S01310

Bastone di plastica, diametro mm 25, lunghezza cm 120
Plastic gymnastic stick, diameter 25 mm, length 120 cm

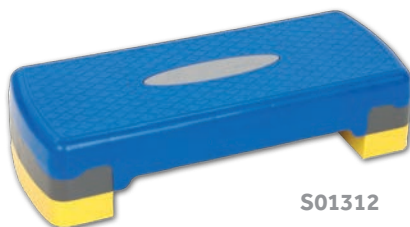

S01312

S01312

Step in plastica componibile ad altezza variabile
Plastic step with adjustable height

S01314

35 / 210

**S01314**

Mini trampolino, diametro cm 90, altezza cm 20
Mini trampoline, round shape diameter 90 cm, height 20 cm

24

**Accessori per
ginnastica propriocettiva**
**Accessories for
rehabilitation gymnastic**



S01402

S01402

Pedana oscillante di legno cm 80x60x13
Wooden balancing board, dimensions 80x60x13 cm



S01404

S01404

Pedana oscillante di legno cm 170x60x13
Wooden balancing board, dimensions 170x60x13 cm

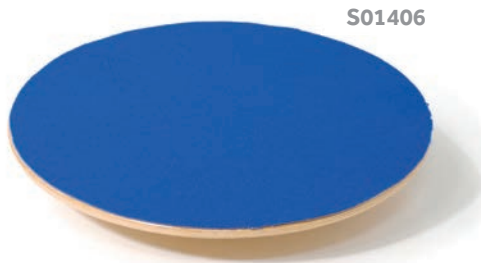

S01406

S01406

Dondolo Bobath di legno, diametro cm 80, altezza cm 10
Wooden Bobath balancing board, round surface, diameter 80 cm, height 10 cm



S01412

S01412

Semisfera Medusa con antiscivolo
Medusa inflatable balancing ball



S01424

S01424

Materassina individuale pieghevole rivestita di vinile, cm 180x60x4
Individual folding exercise mat, covered with vinyl material, 180x60x4 cm



S01408

S01408

Temix attrezzo per ginnastica propriocettiva e riabilitazione
Temix step device for training and rehabilitation therapy



25

**Accessori per
 Yoga e Pilates
 Accessories for
 Yoga and Pilates**



S01426

S01426

Stuoia Yoga arrotolabile in PVC, dimensioni cm 168x61x0,3
Yoga rollable mat made of PVC, dimensions 168x61x0.3 cm



S01410

S01410

Tavoletta Proprio di legno con palla elittica gonfiabile adatta per la ginnastica riabilitativa
Proprio wooden platform for training and rehabilitation therapy

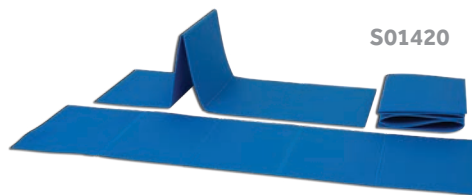

S01420

S01420

Stuoia pieghevole gofrata cm 180x50x0,8 in polietilene
Polyethylene folding mat 180x50x0.8 cm



S01428

S01428

Mattone Yoga in EVA, dimensioni cm 20x12x7,5
Yoga block made in EVA, dimensions 20x12x7.5 cm



S01422

S01422

Stuoia arrotolabile colorata cm 150x70x1, fondo antiscivolo
Coloured rollable mat 150x70x1 cm, slip-proof bottom side



S01432

S01432

Pilates roller ball gonfiabile, diametro cm 15, lunghezza cm 75
Pilates roller ball inflatable, diameter 15 cm, length 75 cm



S01434

S01434

Pilates roller foam in gomma espansa, diametro cm 15, lunghezza cm 90
Pilates roller foam, diameter 15 cm, length 90 cm



S01436

S01436

Fit Circle, anello elastico con impugnatura
Fit Circle elastic ring with handle



S01438

S01438

Pilates Dome, semisfera gonfiabile con elastici e maniglie
Pilates Dome inflatable semi-sphere with elastics and handles

S01440

**S01440**

Cuneo lombare per Pilates, rivestito di tessuto sintetico
Half roll for Pilates exercises, covered by synthetic material

26

Percorsi ed accessori per attività psicomotorie Equipment for psychomotor activities

37 / 210

S01453

Base semisferica per attività psicomotorie, in plastica zavorrabile, sagomata per supportare cerchi e bastoni, diametro cm 20
Half-spherical base for psychomotor activities, made of plastic to be filled, shaped in order to support hoops and sticks, diameter 20 cm



S01453

S01454

Cono di materiale plastico, altezza cm 30 con fori
Coloured plastic cone height 30 cm with holes

S01456

Cono di materiale plastico, altezza cm 50 con fori
Coloured plastic cone height 50 cm with holes



S01456

S01458

Cerchio di nylon colorato, sezione piatta, diametro cm 60
Coloured nylon hoop, flat section, diameter 60 cm

S01460

Cerchio di nylon colorato, sezione piatta, diametro cm 70
Coloured nylon hoop, flat section, diameter 70 cm

**S01462**

Bastone di plastica, diametro mm 25, lunghezza cm 120
Plastic gymnastic stick, diameter 25 mm, length 120 cm





S01476

S01476

Anello di gomma liscia colorata,
diametro cm 18
*Coloured rubber gym ring, diameter
18 cm*



S01480

S01480

Set articoli ed accessori per
psicomotricità fornito su
carrello in legno S00366
*Set of articles and accessories
for psychomotor activities
supplied with wooden trolley
S00366*



S01482

S01482

Tamburello completo di baticchio
Tambourine with stick

S01484

Cembalo di legno con sonagli
Wooden tambourine with metal jingles



S01484

27

Figure geometriche in gomma - Soft geometric construction elements

NOTE

Figure geometriche in gomma disponibili,
su richiesta, anche in altre dimensioni, oltre a
quelle elencate.

*Soft geometric construction elements available, on
demand, with sizes different from those listed.*

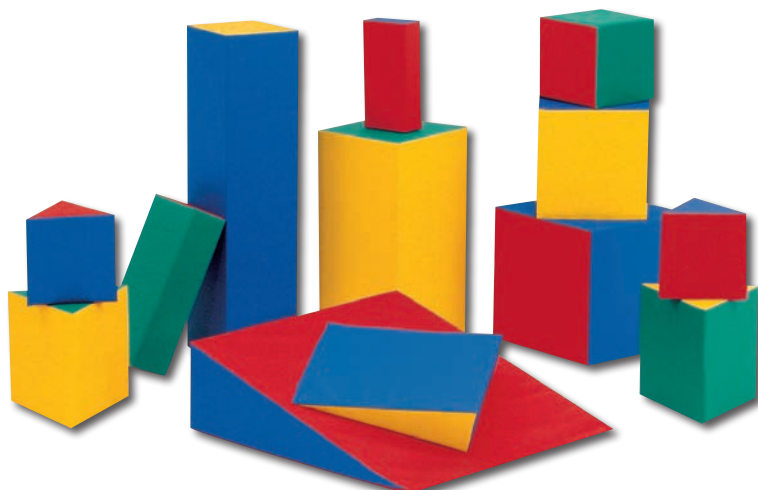
**S01492**

Triangolo, lato cm 30
Triangle, side 30 cm

S01494

Cubo cm 30x30x30
Cube 30x30x30 cm

S01496

Parallelepipedo cm 60x30x15
Block 60x30x15 cm

S01498

Cilindro diametro cm 25, lunghezza cm 100
Cylinder diameter 25 cm, length 100 cm

S01500

Cilindro diametro cm 25, lunghezza cm 50
Cylinder diameter 25 cm, length 50 cm

S01502

Mezzocilindro diametro cm 25, lunghezza cm 50
Half cylinder diameter 25 cm, length 50 cm

S01504

Cuneo cm 100x100x40
Wedge-shaped 100x100x40 cm

S01506

**S01506**

Percorso gioco: scala, ruota, supporto ruota, cuneo, scivolo
 Construction set made of: step, circle, circle's support, wedge-shaped, slope

S01508 39 / 210

**S01508**

Piscina quadrata con elementi accostabili mediante Velcro (palline escluse), dimensioni cm 200x200x50
 Ball pool with soft foam walls to be easily attached one to the other (balls not included), dimensions 200x200x50 cm



S01510

S01510

Materasso pouf cm 200x200x30, super soffice
 Pouf mat 200x200x30 cm, extra soft

28

Palle psicomotricità, air ball, palle con maniglia e varie
Psychomotor balls, air balls, bouncing balls and other balls

S01520

**S01520**

Palla per psicomotricità, diametro cm 45
 Psychomotor ball, diameter 45 cm

S01522

Palla per psicomotricità, diametro cm 55
 Psychomotor ball, diameter 55 cm

S01524

Palla per psicomotricità, diametro cm 65
 Psychomotor ball, diameter 65 cm

S01526

Palla per psicomotricità, diametro cm 85
 Psychomotor ball, diameter 85 cm

S01528

Palla per psicomotricità, diametro cm 120
 Psychomotor ball, diameter 120 cm

S01530

**S01530**

Physio Roll per attività psicomotorie, diametro cm 40, lunghezza cm 65
 Physio Roll for psychomotor activities, diameter 40 cm, length 65 cm

**S01532**

Palla air ball super soft diametro cm 12
Air ball super soft diameter 12 cm



S01538

S01538

Palla in gomma gonfiabile con
impugnatura, diametro cm 40
Rubber reinflatable bouncing ball with
handle, diameter 40 cm



S01544

S01544

Pallone sonoro super soffice
Super soft ball with hidden jingle

S01534

Palla air ball super soft diametro cm 18
Air ball super soft diameter 18 cm

S01540

Palla in gomma gonfiabile con
impugnatura, diametro cm 55
Rubber reinflatable bouncing ball with
handle, diameter 55 cm

S01536

Palla air ball super soft diametro cm 24
Air ball super soft diameter 24 cm

S01542

Palla in gomma gonfiabile con
impugnatura, diametro cm 65
Rubber reinflatable bouncing ball with
handle, diameter 65 cm



S01548

S01548

Palla di spugna colorata, diametro
mm 200
Coloured foam sponge ball, diameter
200 mm



S01550

S01550

Pallina di gomma bugnata colorata,
diametro cm 12, peso gr 100
Easy grip wrinkled rubber ball, diameter
12 cm, weight 100 gr



Inquadra il QR Code di sinistra col tuo cellulare per accedere
alla sezione Ginnastica del sito www.sportssystem.it

Scan the QR Code at your right with your mobile phone to
navigate the Gymnastics section at www.sportssystem.it site



LINK

S01602

**S01602**

Sbarra per danza di legno verniciato, lunghezza a richiesta fino ad un massimo di mt 4
Varnished wooden ballet barre, length at request up to max 4 mt

**S01604**

Supporto fisso per sbarra danza, di acciaio verniciato da fissare a parete
Wall mounted varnished steel support for ballet barre, fixed height

S01606

Supporto regolabile per sbarra danza, di acciaio verniciato da fissare a parete
Wall mounted varnished steel support for ballet barre, height adjustable

S01608

Supporto regolabile per sbarra danza, di acciaio verniciato da fissare a pavimento
Varnished steel support for ballet barre, to be fixed to the floor, height adjustable

NOTE

Studiamo la soluzione migliore per arredare i vostri spazi con sbarre danza e relativi supporti.

We find the best solution to equip your ballet room with barres and corresponding supports.

S01610

**S01610**

Supporto regolabile per sbarra danza, di acciaio verniciato con base maggiorata autoportante, smontabile
Varnished steel support for ballet barre, self standing heavy base, height adjustable, can be dismantled

30

**Specchi
Mirrors****S01622**

Specchio in vetro temperato quadrettato con cornice di legno, cm 100x200 h, inclinazione regolabile, mobile su carrello
Tempered glass mirror with print-on grid pattern and wooden frame, 100x200 h cm, adjustable inclination, transportable on trolley

S01624

**S01624**

Specchio in vetro temperato quadrettato con cornice di legno, da fissare a parete, cm 100x200 h
Tempered glass mirror with print-on pattern and wooden frame, to be fixed to the wall, dimensions 100x200 h cm

S01626

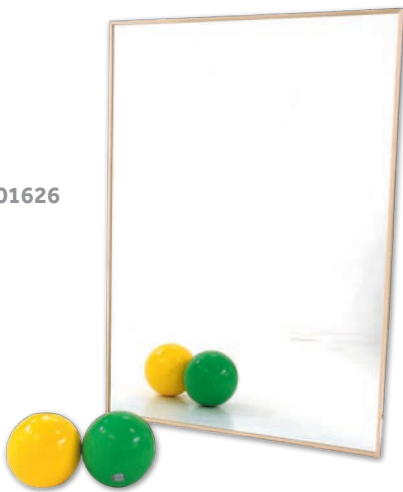
**S01626**

Specchio in vetro temperato liscio con cornice di legno, da fissare a parete, dimensioni a richiesta
Tempered glass plain mirror with wooden frame, to be fixed to the wall, dimensions on demand

31

Bilancieri, manubri, accessori
Barbells, dumbbells, accessories
**S01652**

Bilanciere di acciaio, diametro mm 25, lunghezza cm 150
Training barbell bar, diameter 25 mm, length 150 cm

S01654

Bilanciere di acciaio, diametro mm 25, lunghezza cm 180
Training barbell bar, diameter 25 mm, length 180 cm

S01658

Bilanciere olimpionico, diametro mm 50, lunghezza cm 150
Olympic barbell bar, diameter 50 mm, length 150 cm

S01660

Bilanciere olimpionico, diametro mm 50, lunghezza cm 180
Olympic barbell bar, diameter 50 mm, length 180 cm

S01662

Bilanciere olimpionico, diametro mm 50, lunghezza cm 220
Olympic barbell bar, diameter 50 mm, length 220 cm

S01664

Bilanciere angolato di acciaio, diametro mm 25, lunghezza cm 145
Curl bar, diameter 25 mm, length 145 cm

S01664

S01654



S01666

S01666

Manubrio di acciaio, diametro mm 25, fisso
Dumbbell bar, diameter 25 mm, fixed handle

S01668

**S01668**

Dischi di ghisa ricoperti di gomma, foro diametro mm 26
Weight plates rubber covered, hole diameter 26 mm

S01670

**S01670**

Dischi olimpionici in ghisa gommata, foro diametro mm 50, impugnatura tri-grip per facilitare la presa
Olympic weight plates rubber covered, holed diameter 50 mm, triple grips

S01674

**S01674**

Manubri di ghisa rivestiti di PVC colorato
(kg 0,5 - 1 - 2 - 3 - 4 - 5)

*Pvc covered iron dumbbells
(0,5 - 1 - 2 - 3 - 4 - 5 kg)*

**S01676**

Paio manubri di plastica colorata kg 1
*Pair of coloured plastic dumbbells weight
1 kg*

**S01678**

Paio manubri di plastica colorata kg 2
*Pair of coloured plastic dumbbells weight
2 kg*

**S01680**

Paio manubri di plastica colorata kg 3
*Pair of coloured plastic dumbbells weight
3 kg*

**S01682**

Paio manubri di plastica colorata kg 4
*Pair of coloured plastic dumbbells weight
4 kg*

**S01684**

Paio manubri di plastica colorata kg 5
*Pair of coloured plastic dumbbells weight
5 kg*

**S01686**

Manubri fissi con rivestimento in gomma ed impugnatura
ergonomica antiscivolo, disponibili da kg 2 a kg 40
*Fixed dumbbell covered in rubber with ergonomic and non-slip
handle, available from 2 kg to 40 kg*

**S01687**

Kettlebell in ghisa di colore nero opaco per Cross Training.
Disponibili da kg 8 a 36
*Kettlebell made of cast iron painted in matt black for Cross
Training. Available from 8 to 36 kg*

S01688

**S01688**

Rastrelliera porta manubri a 3 ripiani in acciaio verniciato
Varnished steel dumbbell rack with 3 shelves

S01690

**S01690**

Rastrelliera porta manubri, dischi e bilancieri, in acciaio
verniciato
*Varnished steel rack supporting dumbbell, weight plates and
barbell bars*

Panche per addominali e sollevamento pesi, multifunzione
Abdominal and weightlifting benches, multigym

S01702

**S01702**

Panca pieghevole imbottita per addominali
Padded foldable bench for abdominal exercises

S01704

Panca semplice con supporto per bilanciere e leg extension
Practice bench with barbell supports and leg extension



S01704



S01706

S01706

Panca per sollevamento pesi con schienale e sedile ad inclinazione regolabile su struttura in acciaio verniciato
Slant bench for weightlifting, backrest and seating element adjustable on varnished steel frame

S01708

**S01708**

Panca multiuso con supporti per bilanciere, leg extension, arm curl
Multipurpose bench with barbell supports, leg extension, arm curl

S01710

Panca multipla, leg extension, pectoral
Multi gym machine, leg extension, pectoral

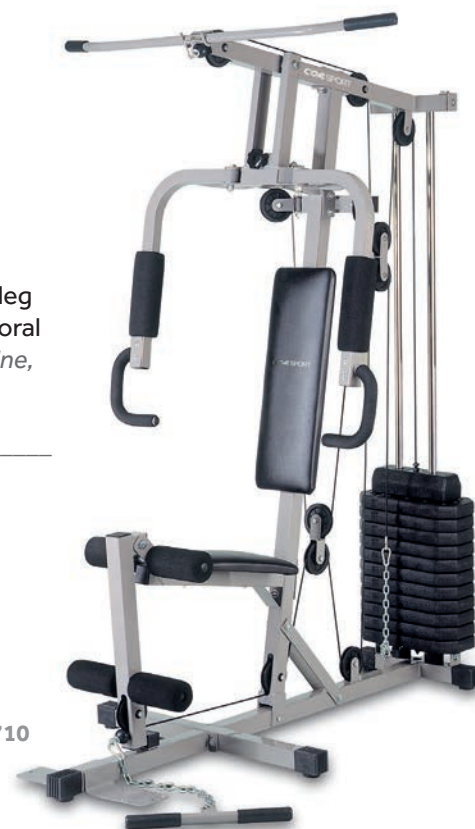

S01710

S01712

Coppia supporti per bilanciere regolabili in altezza
Pair of height adjustable barbell supports



S01722

S01722

Estensore a 5 molle di acciaio
Five springs chest expander



S01728

S01728

Cintura imbottita per sollevamento pesi
Padded belt for weightlifting



S01730

S01730

Paia polsiere zavorrate a pesi estraibili,
kg 2,7
*Pair of dead weight wrist bands,
adjustable weight, 2.7 kg*



S01732

S01732

Paia cavigliere zavorrate a pesi
estraibili, kg 4,5
*Pair of dead weight ankle bands,
adjustable weight, 4.5 kg*

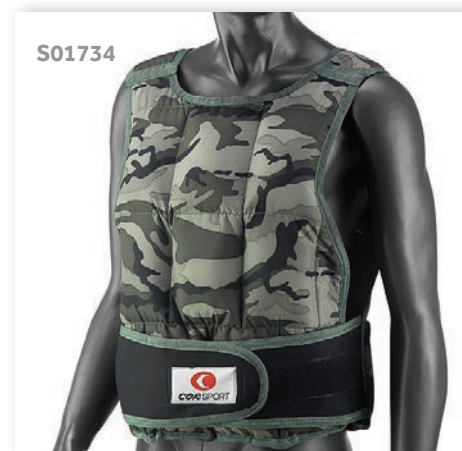

S01734

S01734

Giubbino zavorrato, peso graduabile
fino a kg 10
*Dead weight vest, adjustable weight up
to 10 kg*



S01762

S01762

Sacco boxe rivestito
PVC, kg 40
*Punching bag covered
with PVC, 40 kg*



S01766

S01766

Sacco boxe rivestito
PVC con fascia di
cuoio, kg 40
*Punching bag covered
with PVC, leather
central strip, 40 kg*



S01770

S01770

Sacco boxe rivestito
di similpelle, kg 40
*Punching bag
synthetic leather
covered, 40 kg*

S01764

Sacco boxe rivestito PVC, kg 50
Punching bag covered with PVC, 50 kg

S01768

Sacco boxe rivestito PVC con fascia di
cuoio, kg 50
*Punching bag covered with PVC, leather
central strip, 50 kg*

S01772

Sacco boxe rivestito di similpelle, kg 50
*Punching bag synthetic leather covered,
50 kg*



S01774

S01774

Mensola per sacco boxe da fissare a parete

Varnished steel rack for punching bag to be fixed to the wall

S01776

**S01776**

Estensore per sacco boxe

Expanding chain for punching bag



S01778

S01778

Sacco boxe con base riempibile, altezza regolabile

Punching bag with standing base to be filled, adjustable height



S01780

S01780

Punching ball su base in vinile, regolabile in altezza

Flexible punching ball with standing vinyl base, adjustable in height



S01782

S01782

Piattaforma per punching ball, completa di pera

Wall platform for punching ball, including speed ball



S01784

S01784

Caschetto boxe in pelle sintetica (M-L)

Synthetic leather boxing helmet (M-L)



S01786

S01786

Corpetto paracolpi reversibile, colore blu o rosso (JR-SR)

Double face chest protector, red or blue color (JR-SR)



S01788

S01788

Paio guanti boxe pelle sintetica (8-10-12 once)

Pair boxing gloves synthetic leather (8-10-12 once)



S01790

S01790

Ring boxe regolamentare con misura interno corde cm 550x550 su struttura in acciaio verniciato. Completo di colonne imbottite, corde, 2 scalette, tatami in gomma e copertura laterale in PVC

Regular size boxing ring 550x550 cm between ropes on varnished steel structure. Complete of padded columns, ropes, 2 entry ladders, mat surface and side covers in PVC



ATLETICA

La presente categoria è strutturata in una serie ordinata di sottocategorie, ciascuna delle quali dedicata ad una specifica disciplina dell'atletica e ciascuna comprendente sia **attrezzature ed articoli destinati all'allenamento** sia **alternative omologate WA per competizioni**.

Iniziando dalle **discipline su pista** la categoria prosegue quindi con i titoli dedicati alle **discipline da lancio** per finire con le **specialità del salto**.

ATHLETICS

*This category consists of several different groups of equipment and accessories each one dedicated to a different athletics' discipline and consisting both of **training solutions** as well as **WA approved alternatives**.*

*Starting from **track's disciplines** the category continues with **throwing events' equipment and accessories** and ends with products for **jumping events**.*

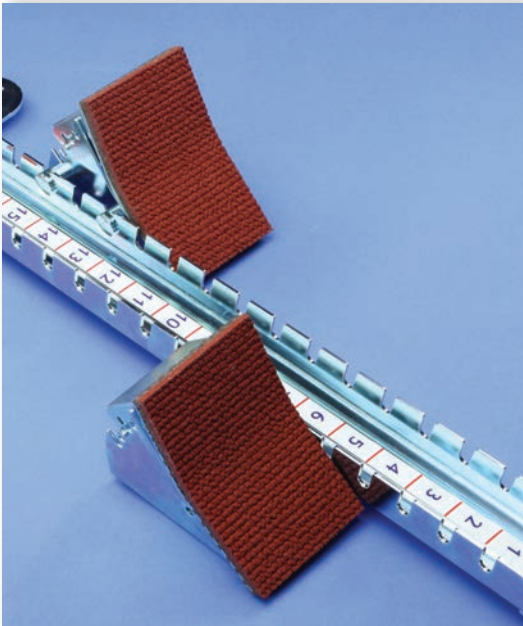

1

Blocchi di partenza, testimoni Starting blocks, relay batons

S02002



S02002

Paia blocchi di partenza in gomma per palestra
Pair of rubber starting blocks for indoor use

S02004

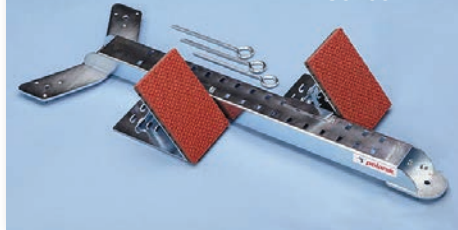

S02004

Blocco di partenza da allenamento in acciaio zincato
Practice starting blocks made of galvanized steel

S02006

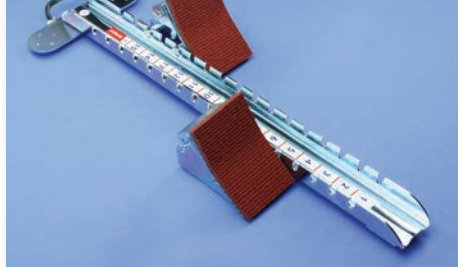

S02006

Blocco di partenza in acciaio zincato omologato WA per competizioni
Galvanized steel starting blocks WA approved for competition

S02008

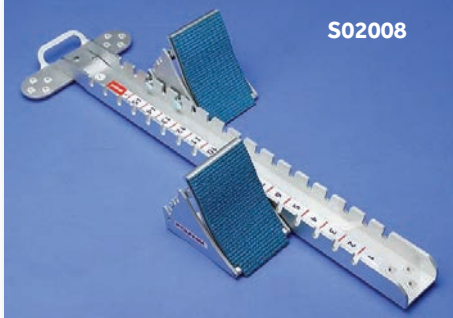

S02008

Blocco di partenza in alluminio omologato WA per competizioni
Aluminium starting blocks WA approved for competition

S02010



S02010

Testimone staffetta di plastica
Plastic relay baton

S02012



S02012

Testimone staffetta di alluminio per allenamento
Aluminium practice relay baton

S02014



S02014

Testimone staffetta di alluminio omologato WA per competizioni
Aluminium relay baton WA approved for competition

2

Ostacoli Hurdles

49 / 210

S02052



S02052

Set ostacoli Over, 10 pezzi ad altezze differenti
Set of 10 practice Over hurdles with different heights

S02054

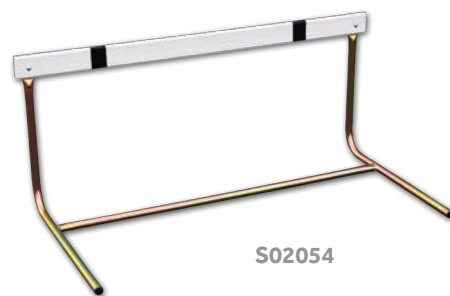

S02054

Ostacolo in acciaio per allenamento, altezza fissa cm 50
Steel practice hurdle, fixed height 50 cm

S02056



S02056

Ostacolo in acciaio per allenamento, altezza regolabile cm 50/60/76,2
Steel practice hurdle, adjustable height 50/60/76.2 cm



S02058

S02058

Ostacolo in acciaio per allenamento, antinfortunistico con ritorno a molla, altezza regolabile cm 50/60/76,2
Steel practice hurdle, safety pendular model with tension spring, adjustable height 50/60/76.2 cm



S02070

S02070

Ostacolo olimpionico in acciaio ed alluminio, altezza regolabile cm 76,2/84/91,4/100/106,7 omologato WA per competizioni
Olympic hurdle made of steel and aluminium, adjustable height 76.2/84/91.4/100/106.7 cm WA approved for competition



S02076

S02076

Carrello porta ostacoli in acciaio zincato, mobile su ruote
Galvanized steel trolley for hurdles, mobile on wheels



S02060

S02060

Ostacolo in acciaio per allenamento, altezza regolabile cm 76,2/84/91,4
Steel practice hurdle, adjustable height 76.2/84/91.4 cm



S02072

S02072

Ostacolo olimpionico in alluminio, altezza regolabile cm 76,2/84/91,4/100/106,7 omologato WA per competizioni
Olympic hurdle made of aluminium, adjustable height 76.2/84/91.4/100/106.7 cm WA approved for competition



S02078

S02078

Ostacolo per riviera corsa siepi in acciaio zincato, trave di legno lunghezza cm 366, regolabile in altezza
Water jump steeplechase hurdle, galvanized steel structure, wooden bar 366 cm long, adjustable height

S02064

Ostacolo in acciaio con altezza regolabile cm 76,2/84/91,4/100/106,7
Steel professional hurdle, adjustable height 76.2/84/91.4/100/106.7 cm



S02068

S02068

Ostacolo olimpionico per competizioni, in acciaio con contrappesi, altezza regolabile cm 76,2/84/91,4/100/106,7
Olympic competition hurdle made of steel, counterweighted base, adjustable height 76.2/84/91.4/100/106.7 cm



S02074

S02074

Asticella di ricambio per ostacoli in plastica
Plastic replacement bar for hurdles



S02080

S02080

Ostacolo per riviera corsa siepi omologato WA per competizioni
Water jump steeplechase hurdle WA approved for competition



S02082

S02082

Serie ostacoli mobili per corsa siepi in acciaio zincato, travi di legno regolabili in altezza (1 ostacolo cm 500, 3 ostacoli cm 396)

Set of mobile steeplechase hurdles, galvanized steel structure, wooden bar adjustable height (1 hurdle 500 cm, 3 hurdles 396 cm)



S02084

S02084

Serie ostacoli mobili per corsa siepi omologati WA per competizioni (1 ostacolo cm 500, 3 ostacoli cm 396)

Set of mobile steeplechase hurdles WA approved for competition (1 hurdle 500 cm, 3 hurdles 396 cm)

S02086

Carrello per trasporto ostacoli corsa siepi in acciaio zincato, mobile su ruote
Galvanized steel trolley for steeplechase hurdles, mobile on wheels

51 / 210

3

Scale e accessori per giudici - Stands and accessories for referees

S02102

S02102

Scala giudici traguardo e cronometristi a 6 posti in acciaio zincato, mobile su ruote

Judges and timekeepers mobile stand made of galvanized steel, 6 places

S02104

Scala giudici traguardo e cronometristi a 12 posti in acciaio zincato, mobile su ruote

Judges and timekeepers mobile stand made of galvanized steel, 12 places



S02106

S02106

Tavolo giudici di resina per esterno
Judges plastic table for outdoor use



S02108

S02108

Sedia giudici di resina per esterno

Judges plastic chair for outdoor use

S02110

Ombrellone parasole completo di basamento
Outdoor parasol umbrella with plastic base



S02112

S02112

Megafono a transistor portatile
Hand transistor megaphone



S02114

S02114

Bandierina per giudici rossa, bianca o gialla
Judges flag red, white or yellow



S02116

S02116
 Contagiri in acciaio zincato con
 campana
Galvanized steel lap indicator with bell



S02118

S02118
 Segnalatore numerico a 8 cifre in
 acciaio zincato, completo di sedile,
 mobile su ruote
*Mobile field event scoreboard in
 galvanized steel with 8 figures, complete
 of seat*



S02120

S02120
 Segnalatore numerico a 8 cifre in
 acciaio zincato, su basamento
 girevole con ruote
*Mobile revolving field event scoreboard
 in galvanized steel with 8 figures*



S02122

S02122
 Bilancia pesa attrezzi elettronica
 digitale
Digital electronic equipment scale



S02123

S02123
 Kit controllo attrezzi da lancio,
 su sacca in nylon
*Set of measuring devices for throwing
 events, on nylong bag*



S02124

S02124
 Sgabello per starter in acciaio zincato
 mobile su ruote
*Galvanized steel starter rostrum mobile
 on wheels*



S02126

S02126
 Pistola per starter a tamburo
Starting revolver gun



S02128

S02128
 Confezione cartucce per pistola starter
Box of blanks for starting revolver gun



S02154

S02154

Cronometro digitale, precisione 1/100 di secondo

Digital stopwatch, precision 1/100 seconds



S02158

S02158

Cronometro digitale, precisione 1/100 di secondo, 100 memorie

Digital stopwatch, precision 1/100 seconds, 100 memories



S02160

S02160

Cronometro rilevazione tempi completo di stampante

Portable timing system with printer

S02164

Ponte porta lampade per fotofinish, in acciaio zincato, per pista a 6 corsie

Galvanized steel structure for 6 lanes track supporting photofinish lamps

S02166

Ponte porta lampade per fotofinish, in acciaio zincato, per pista a 8 corsie

Galvanized steel structure for 8 lanes track supporting photofinish lamps

S02202

**S02202**

Piramide segna corsia numerata, di acciaio verniciato

Varnished steel lane marker box

S02206

Bandierina per rientro al cordolo

Finish flag with plastic flagpole

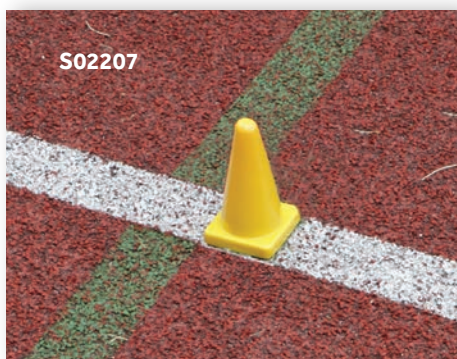

S02207

S02204

Piramide segna corsia numerata, di vetroresina

Fibreglass lane marker box

S02207

Mini cono di segnalazione della riga di rientro

Mini-cone marking the entry lane

S02208

**S02208**

Cono di plastica, altezza cm 30

Plastic marking cone, height 30 cm



S02210

S02210
Cono di plastica, altezza cm 50
Plastic marking cone, height 50 cm



S02212

S02212
Fettuccia segna corsie di plastica in rotoli da mt 150
White pvc sector line marker tape in roll of 150 mt



S02214

S02214
Ferma fettuccia di acciaio zincato
Galvanized steel fixing pin for marking tape



S02216

S02216
Piramide segna settore numerata di acciaio verniciato
Varnished steel distance marker box



S02218

S02218
Piramide segna settore numerata di vetroresina
Fibreglass distance marker box



S02220

S02220
Serie di bandierine segnarecord in acciaio verniciato
Set of varnished steel record marker flags



S02222

S02222
Palina segna lanci numerata di acciaio verniciato
Varnished steel distance marker



S02224

S02224
Coppia pali traguardo in acciaio zincato con bussole da cementare
Pair of galvanized steel finish posts with sockets to be concreted in

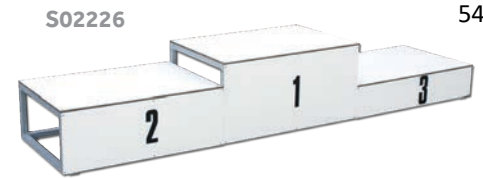

S02226

S02226
Podio per vincitori a 3 gradini con struttura in acciaio zincato
Victory stand at 3 steps with galvanized steel structure



S02228

S02228
Podio per vincitori composto da 3 moduli indipendenti in vetroresina
Victory stand made of 3 separate fibreglass steps



S02230



S02230

S02230
Panchina doppia per atleti con 8 sedute in polipropilene su struttura in acciaio zincato, mobile su ruote, con copertura
Mobile athletes double bench with 8 plastic seats mounted onto galvanized steel structure, mobile on wheels, equipped with protective roof

Rotelle metriche - *Measuring tapes***S02252**

Rotella metrica da mt 20 di fiberglass, con impugnatura

Fibreglass measuring tape 20 mt, with handle

**S02256**

Rotella metrica da mt 20 di acciaio, con impugnatura

Steel measuring tape 20 mt, with handle

S02254

Rotella metrica da mt 50 di fiberglass, con impugnatura

Fibreglass measuring tape 50 mt, with handle

S02258

Rotella metrica da mt 50 di acciaio, con impugnatura

Steel measuring tape 50 mt, with handle

S02260

Rotella metrica da mt 100 di acciaio, con impugnatura

Steel measuring tape 100 mt, with handle

**S02262**

Contametri stradale a lettura doppia, con maniglia

Measuring wheel with handle

Articoli per lancio del disco - *Discus throwing equipment***S02302**

Disco di gomma da allenamento, kg 1

Training rubber discus, 1 kg

S02304

Disco di gomma da allenamento, kg 1,500

Training rubber discus, 1.500 kg

S02306

Disco di gomma da allenamento, kg 1,750

Training rubber discus, 1.750 kg

S02308

Disco di gomma da allenamento, kg 2

Training rubber discus, 2 kg

S02310

Disco da allenamento Polanik di plastica bordato acciaio, kg 0,750

Polanik training plastic discus with steel rim, 0.750 kg

S02312**S02312**

Disco da allenamento Polanik di plastica bordato acciaio, kg 1

Polanik training plastic discus with steel rim, 1 kg

S02314

Disco da allenamento Polanik di plastica bordato acciaio, kg 1,500

Polanik training plastic discus with steel rim, 1.500 kg

S02316

Disco da allenamento Polanik di plastica bordato acciaio, kg 1,750

Polanik training plastic discus with steel rim, 1.750 kg

S02318

Disco da allenamento Polanik di plastica bordato acciaio, kg 2

Polanik training plastic discus with steel rim, 2 kg



S02320

Disco Polanik di nylon bordato acciaio, kg 1 omologato WA per competizioni
Polanik nylon discus with steel rim, 1 kg WA approved for competition

S02322

Disco Polanik di nylon bordato acciaio, kg 1,500 omologato WA per competizioni
Polanik nylon discus with steel rim, 1.500 kg WA approved for competition

S02324

Disco Polanik di nylon bordato acciaio, kg 1,750 omologato WA per competizioni
Polanik nylon discus with steel rim, 1.750 kg WA approved for competition

S02326

Disco Polanik di nylon bordato acciaio, kg 2 omologato WA per competizioni
Polanik nylon discus with steel rim, 2 kg WA approved for competition



S02328

Carrello porta dischi in acciaio zincato, mobile su ruote
Galvanized steel trolley for discus, mobile on wheels

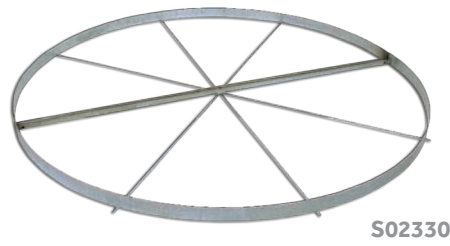

S02330

Pedana per lancio del disco di acciaio zincato, diametro cm 250, in 2 elementi
Discus throwing circle made of galvanized steel, diameter 250 cm, made of 2 parts



S02332

Gabbia di protezione per lancio del disco (e martello) di acciaio zincato, altezza mt 7, completa di rete e portelloni mobili
Protective cage for discus (and hammer) throwing made of galvanized steel, height 7 mt, including doors and net



S02336

Gabbia di protezione per lancio del disco (e martello) in alluminio, omologata WA per competizioni
Protective cage for discus (and hammer) throwing made of aluminium, WA approved for competition

S02338

Rete di nylon per gabbia di protezione con altezza mt 7
Net for protective cage of 7 mt



LINK

Inquadra il QR Code di sinistra col tuo cellulare per accedere alla sezione Atletica del sito www.sportssystem.it

Scan the QR Code at your right with your mobile phone to navigate the Athletics section at www.sportssystem.it site



S02351

**S02351**

Junior Jav da gr 80 propedeutico al lancio del giavelotto

Junior Jav of 80 gr for practicing on javelin throwing

S02358

Giavelotto Polanik di alluminio da allenamento, peso gr 600

Polanik aluminium javelin for training, weight 600 gr

S02360

Giavelotto Polanik di alluminio da allenamento, peso gr 700

Polanik aluminium javelin for training, weight 700 gr

S02366

Giavelotto Polanik di alluminio, peso gr 600 per lanci fino a mt 60, omologato WA per competizioni

Polanik aluminium javelin, weight 600 gr, up to 60 mt throw, WA approved for competition

S02368

Giavelotto Polanik di alluminio, peso gr 700 per lanci fino a mt 65, omologato WA per competizioni

Polanik aluminium javelin, weight 700 gr, up to 65 mt throw, WA approved for competition



S02352

S02352

Turbo Jav propedeutico al lancio del giavelotto

Turbo Jav practice javelin made in coloured plastic

S02362

Giavelotto Polanik di alluminio da allenamento, peso gr 800

Polanik aluminium javelin for training, weight 800 gr

S02370

Giavelotto Polanik di alluminio, peso gr 800 per lanci fino a mt 80, omologato WA per competizioni

Polanik aluminium javelin, weight 800 gr, up to 80 mt throw, WA approved for competition



S02354

S02354

Vortex propedeutico al lancio del giavelotto

Vortex for practicing on javelin throwing, made in soft plastic



Competition



S02372

S02372

Carrello porta giavelotti in acciaio zincato, mobile su ruote

Galvanized steel trolley for javelins, mobile on wheels

Training

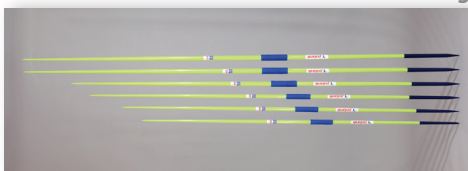
**S02356**

Giavelotto Polanik di alluminio da allenamento, peso gr 400

Polanik aluminium javelin for training, weight 400 gr

S02364

Giavelotto Polanik di alluminio da competizione, peso gr 400

Polanik aluminium javelin for competition, weight 400 gr



S02374

S02374

Borsa per trasporto giavelotti, capacità 5 pezzi

Javelin bag holding 5 javelins

S02357

Giavelotto Polanik di alluminio da allenamento, peso gr 500

Polanik aluminium javelin for training, weight 500 gr

S02365

Giavelotto Polanik di alluminio da competizione, peso gr 500

Polanik aluminium javelin for competition, weight 500 gr



S02402

Martello da allenamento Polanik di ferro tornito e calibrato, peso kg 3
Polanik turned steel hammer for training, weight 3 kg

S02404

Martello da allenamento Polanik di ferro tornito e calibrato, peso kg 4
Polanik turned steel hammer for training, weight 4 kg

S02406

Martello da allenamento Polanik di ferro tornito e calibrato, peso kg 5
Polanik turned steel hammer for training, weight 5 kg

S02408

Martello da allenamento Polanik di ferro tornito e calibrato, peso kg 6
Polanik turned steel hammer for training, weight 6 kg

S02410

Martello da allenamento Polanik di ferro tornito e calibrato, peso kg 7,260
Polanik turned steel hammer for training, weight 7.260 kg

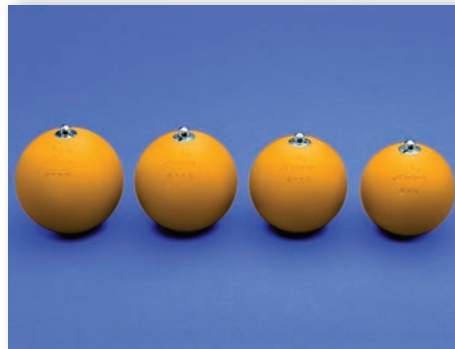

S02412

Martello Polanik di ferro tornito e calibrato da gara, peso kg 4, omologato WA per competizioni
Polanik turned steel hammer, weight 4 kg, WA approved for competition

S02414

Martello Polanik di ferro tornito e calibrato da gara, peso kg 5, omologato WA per competizioni
Polanik turned steel hammer, weight 5 kg, WA approved for competition

S02416

Martello Polanik di ferro tornito e calibrato da gara, peso kg 6, omologato WA per competizioni
Polanik turned steel hammer, weight 6 kg, WA approved for competition

S02418

Martello Polanik di ferro tornito e calibrato da gara, peso kg 7,260, omologato WA per competizioni
Polanik turned steel hammer, weight 7.260 kg, WA approved for competition



S02422

S02422

Carrello porta martelli in acciaio zincato, mobile su ruote
Galvanized steel trolley for hammers, mobile on wheels



S02424

S02424

Anello di riduzione da pedana lancio disco a pedana lancio martello, componibile in 4 elementi di legno
Reduction circle to convert discus to hammer platforms, consist of 4 wooden parts



S02426

S02426

Gabbia di protezione per lancio del martello (e disco) in alluminio, omologata WA per competizioni
Protective cage for hammer (and discus) throwing made of aluminium, WA approved for competition



S02422



S02420

S02420

Filo per martello completo di maniglia
Wire for hammer including handle

**S02452**

Palla getto di gomma anelastica per uso indoor, kg 0,150
Rubber practice throwing ball, not bouncing, 0.150 kg

**S02468**

Palla getto di gomma anelastica per uso indoor, kg 5
Rubber practice throwing ball, not bouncing, 5 kg

**S02454**

Palla getto di gomma anelastica per uso indoor, kg 0,300
Rubber practice throwing ball, not bouncing, 0.300 kg

**S02470**

Palla getto di gomma anelastica per uso indoor, kg 6
Rubber practice throwing ball, not bouncing, 6 kg

**S02456**

Palla getto di gomma anelastica per uso indoor, kg 0,500
Rubber practice throwing ball, not bouncing, 0.500 kg

**S02472**

Palla getto di gomma anelastica per uso indoor, kg 7,260
Rubber practice throwing ball, not bouncing, 7.260 kg

**S02458**

Palla getto di gomma anelastica per uso indoor, kg 0,800
Rubber practice throwing ball, not bouncing, 0.800 kg



S02474

**S02460**

Palla getto di gomma anelastica per uso indoor, kg 1
Rubber practice throwing ball, not bouncing, 1 kg

S02474

Palla getto di gomma kg 2
Rubber shot ball 2 kg

S02480

Palla getto di gomma kg 5
Rubber shot ball 5 kg

**S02462**

Palla getto di gomma anelastica per uso indoor, kg 2
Rubber practice throwing ball, not bouncing, 2 kg

S02476

Palla getto di gomma kg 3
Rubber shot ball 3 kg

S02482

Palla getto di gomma kg 6
Rubber shot ball 6 kg

**S02464**

Palla getto di gomma anelastica per uso indoor, kg 3
Rubber practice throwing ball, not bouncing, 3 kg

S02478

Palla getto di gomma kg 4
Rubber shot ball 4 kg

S02484

Palla getto di gomma kg 7,260
Rubber shot ball 7.260 kg

**S02466**

Palla getto di gomma anelastica per uso indoor, kg 4
Rubber practice throwing ball, not bouncing, 4 kg



S02486

S02486

Palla getto di metallo verniciato da allenamento, tarata kg 2
Varnished metal shot ball for training, gauged 2 kg

S02488

Palla getto di metallo verniciato da allenamento, tarata kg 3
Varnished metal shot ball for training, gauged 3 kg

S02490

Palla getto di metallo verniciato da allenamento, tarata kg 4
Varnished metal shot ball for training, gauged 4 kg

S02492

Palla getto di metallo verniciato da allenamento, tarata kg 5
Varnished metal shot ball for training, gauged 5 kg

S02494

Palla getto di metallo verniciato da allenamento, tarata kg 6
Varnished metal shot ball for training, gauged 6 kg

S02496

Palla getto di metallo verniciato da allenamento, tarata kg 7,260
Varnished metal shot ball for training, gauged 7.260 kg

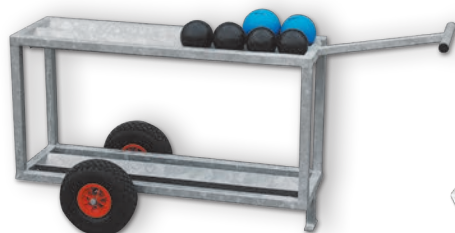

S02508



S02498

S02498

Palla getto Polanik di ferro tornito e calibrato, peso kg 3, omologata WA per competizioni
Polanik turned steel shot ball, weight 3 kg, WA approved for competition

S02500

Palla getto Polanik di ferro tornito e calibrato, peso kg 4, omologata WA per competizioni
Polanik turned steel shot ball, weight 4 kg, WA approved for competition

S02502

Palla getto Polanik di ferro tornito e calibrato, peso kg 5, omologata WA per competizioni
Polanik turned steel shot ball, weight 5 kg, WA approved for competition

S02504

Palla getto Polanik di ferro tornito e calibrato, peso kg 6, omologata WA per competizioni
Polanik turned steel shot ball, weight 6 kg, WA approved for competition

S02506

Palla getto Polanik di ferro tornito e calibrato, peso kg 7,260, omologata WA per competizioni
Polanik turned steel shot ball, weight 7.260 kg, WA approved for competition



S02514



S02508

S02508

Carrello porta palle getto in acciaio zincato, mobile su ruote
Galvanized steel trolley for shot balls, mobile on wheels

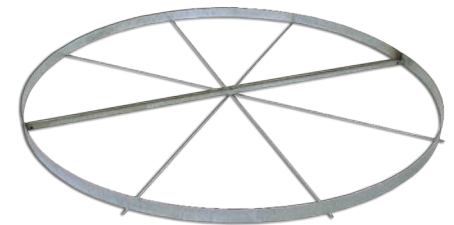

S02510

S02510

Pedana per lancio del peso di acciaio zincato, diametro cm 213,5 in 2 elementi
Shot put throwing circle made of galvanized steel, diameter 213.5 cm made of 2 parts



S02512

S02512

FermapiEDE getto del peso di legno massiccio
Shot put toe board made of wood

S02514

NEW

FermapiEDE getto del peso di vetroresina, omologato WA per competizioni
Shot put toe board made of fiberglass, WA approved for competition

S02552

**S02552**

Coppia ritti per salto in alto scolastici, altezza regolabile fino a cm 200
Pair of practice high jump stands, height adjustable up to 200 cm

S02554

**S02554**

Coppia ritti per salto in alto scolastici, altezza regolabile fino a cm 230
Pair of practice high jump stands, height adjustable up to 230 cm

S02556

**S02556**

Coppia ritti per salto in alto telescopici, altezza regolabile fino a cm 250
Pair of high jump stands, height telescopically adjustable up to 250 cm

S02558

**S02558**

Coppia ritti per salto in alto da gara, regolazione telescopica dell'altezza fino a cm 260
Pair of professional high jump stands, height telescopically adjustable up to 260 cm

S02560

**S02560**

Coppia ritti salto in alto di alluminio da gara, altezza regolabile fino a cm 260
Pair of professional high jump stands made of aluminium, height adjustable up to 260 cm

S02561

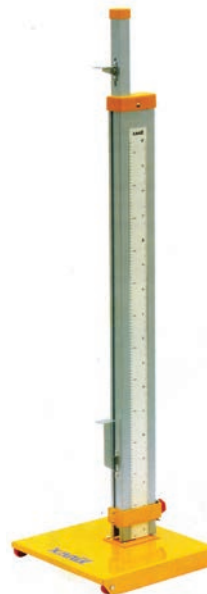
**S02561**

Coppia ritti salto in alto di alluminio, regolazione telescopica dell'altezza, omologati WA per competizioni
Pair of professional high jump stands, telescopic, WA approved for competition

S02562

**S02562**

Coppia ritti salto in alto di alluminio, regolazione telescopica dell'altezza fino a cm 265, omologati WA per competizioni
Pair of professional high jump stands, height telescopically adjustable up to 265 cm, WA approved for competition

S02566



S02566

Asticella segna limite di polietilene espanso, lunghezza mt 4
Polyethylene foam high jump crossbar, length 4 mt

S02576

Area di caduta salto in alto, dimensione cm 400x300x50
High jump landing area, dimension 400x300x50 cm

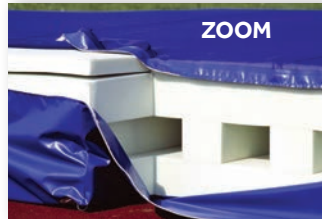

S02578



S02578

Area di caduta salto in alto, dimensione cm 500x300x60
High jump landing area, dimension 500x300x60 cm

S02580

Area di caduta salto in alto, dimensione cm 600x300x70
High jump landing area, dimension 600x300x70 cm

S02582

Area di caduta salto in alto, dimensione cm 600x400x70
High jump landing area, dimension 600x400x70 cm

S02584

Piattaforma di sostegno e sollevamento area di caduta in acciaio zincato
Galvanized steel support platform for raising the high jump landing area



S02584



S02586

S02586

Segnalino di rincorsa di acciaio colorato
Coloured steel run up marker

12

Articoli per salto con l'asta
Pole vault equipment



S02572

S02570

S02570

Asticella segna limite di vetroresina, modello da allenamento, lunghezza mt 4
Fibreglass high jump crossbar for training, length 4 mt

S02572

Asticella segna limite di vetroresina, modello da competizione, lunghezza mt 4
Fibreglass high jump crossbar for competition, length 4 mt



S02574

S02574

Misuratore di alluminio per salto in alto
Aluminium height measurer for high jump



S02602

S02602

Coppia ritti per salto con l'asta di alluminio, altezza regolabile fino a cm 650
Pair of aluminium pole vault stands, height adjustable up to 650 cm



S02603

S02603

Coppia ritti per salto con l'asta di alluminio, altezza regolabile fino a cm 650, omologati WA per competizioni

Pair of aluminium pole vault stands, height adjustable up to 650 cm, WA approved for competition



S02604

S02604

Coppia ritti per salto con l'asta di alluminio, altezza regolabile fino a cm 640, lettura elettronica, omologati WA per competizioni

Pair of aluminium pole vault stands, height adjustable up to 640 cm, electronic height indicator, WA approved for competition



S02610

S02608

S02608

Asticella segna limite di vetroresina, modello da allenamento, lunghezza mt 4,50

Fibreglass pole vault crossbar for training, length 4.50 mt

S02610

Asticella segna limite di vetroresina, modello da competizione, lunghezza mt 4,50

Fibreglass pole vault crossbar for competition, length 4.50 mt

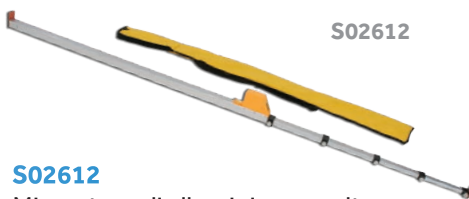

S02612

S02612

Misuratore di alluminio per salto con l'asta

Aluminium height measurer for pole vault

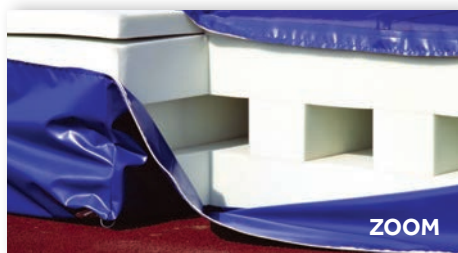

ZOOM

S02614

Area di caduta salto con l'asta, dimensione cm 700x500x80

Pole vault landing area, dimension 700x500x80 cm

S02616

Area di caduta salto con l'asta, dimensione cm 600x700x80

Pole vault landing area, dimension 600x700x80 cm

S02618

Area di caduta salto con l'asta, dimensione cm 600x800x80

Pole vault landing area, dimension 600x800x80 cm



S02620

S02620

Piattaforma di sostegno e sollevamento area di caduta in acciaio zincato

Galvanized steel support platform for raising the pole vault landing area



S02622 - ZOOM

S02622

Asta per salto con l'asta di fibra di vetro, lunghezza e portata a richiesta

Fibreglass vaulting pole, length and loading capacity on demand



S02624

S02624

Segnalino di rincorsa di acciaio colorato

Coloured steel run up marker



S02626

S02626

Cassetta per imbucata asta di acciaio zincato con coperchio

Galvanized steel vault box with cover



S02652

S02652

Asse di battuta in legno per salto in lungo e salto triplo con tavoletta porta plastilina

Sturdy wooden take-off board for long and triple jump with wooden insert for plasticine

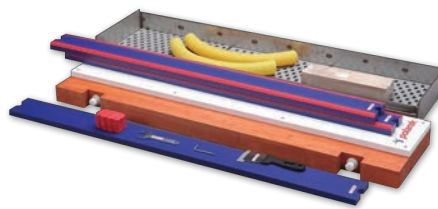

S02658

S02658

Asse di battuta in legno per salto in lungo e salto triplo con cassetta di acciaio inox ed accessori, omologata WA per competizioni

Sturdy wooden take-off board for long and triple jump with stainless steel box and accessories, WA approved for competition



S02664

S02664

Rastrello livellatore per buca sabbia, di acciaio zincato

Galvanized steel rake for sandbox



S02654

S02654

Asse di battuta in acciaio inox e superficie di legno per salto in lungo e salto triplo con tavoletta porta plastilina

Stainless steel take-off board with wooden surface for long and triple jump with wooden insert for plasticine



S02660

S02660

Coppia indicatori asse di battuta in acciaio verniciato

Pair of varnished steel take-off markers



S02666

S02666

Cazzuola per riempimento cassaforma, di acciaio trattato

Steel coated trowel to fill mould



S02656

S02656

Cassetta in acciaio zincato per asse di battuta

Galvanized steel box for take-off board



S02662

S02662

Cassaforma per sabbia in acciaio zincato

Galvanized steel sand box



GIOCHI

Nella categoria Giochi trovano spazio una serie di sottocategorie di articoli ed attrezzature destinate alla pratica dei principali sport individuali e di squadra, a partire **da soluzioni di livello scolastico fino ad alternative omologate per competizioni** dalle rispettive federazioni internazionali.

Tutte le soluzioni presentate, fisse o mobili, per uso indoor o outdoor, **sono agevolmente personalizzabili** in base alle diverse esigenze dei clienti.



GAMES

*This category includes a range of equipment and accessories dedicated to the practice of main individual and team sports, starting **from school level up to professional level** with a selection of alternatives approved by the relevant international sporting federation.*

***All solutions**, portable or fixed, for indoor or outdoor purposes, **can be easily customized** to customer's requirements.*



Strutture ricreative basket, minibasket e baskin Recreational basket, mini-basket and baskin units



made in Italy

S04007

S04007

Struttura trasportabile per gioco baskin, base zavorrabile, palo in acciaio, tabellone in polipropilene, canestri fissi con retina

Portable baskin unit, base to be filled, steel column, polypropylene backboard and fixed rings with net



made in Italy

S04008

S04008

Struttura basket e minibasket trasportabile, base zavorrabile, palo in acciaio, tabellone in polipropilene con canestro fisso e retina

Portable basket and mini-basket unit, base to be filled, steel column, polypropylene backboard and fixed ring with net



made in Italy

S04010

S04010

Struttura basket e minibasket trasportabile, base zavorrabile, palo in acciaio, tabellone in polipropilene con canestro fisso e retina, regolazione automatica dell'altezza

Portable basket and mini-basket unit, base to be filled, steel column, polypropylene backboard and fixed ring with net, automatic height adjustment



made in Italy

S04011

S04011

Protezione frontale imbottita per strutture basket e minibasket S04008 e S04010

Front protection pad for basket and mini-basket units S04008 and S04010



S04012

S04012

Struttura basket e minibasket richiudibile e trasportabile in acciaio verniciato, base porta zavorra, tabellone in resina, canestro fisso e retina, protezione frontale

Foldable and portable basket and mini-basket unit entirely in varnished steel, platform supporting ballast, hpl backboard, fixed ring with net, front protection pad



S04014

S04014

Struttura basket e minibasket monotubolare in acciaio verniciato, mobile su ruote e pieghevole, tabellone in plexiglas, canestro fisso e retina, protezione frontale, zavorra inclusa

Foldable monotubular basket and mini-basket unit movable on wheels, in varnished steel, acrylic glass backboard, fixed ring with net, front protection pad, ballast included

2

Impianti basket a traliccio e monotubolari *Olympic and monotubular basketball backstops*

NOTE

68 / 210

Tutti gli impianti basket presenti in questa sezione sono forniti con canestri **S04232**.

*All basketball backstops included in this section are supplied with rings **S04232**.*



S04020

S04020

Impianto basket olimpionico a traliccio di acciaio zincato, sbalzo cm 225, tabelloni di resina melamminica su telaio, canestri fissi e retine

Olympic basketball backstops, galvanized steel structure projection 225 cm, hpl backboards on steel frame, fixed rings and nets

S04022

Impianto basket olimpionico a traliccio di acciaio verniciato, sbalzo cm 225, tabelloni di nobilitato bilaminato su telaio, canestri fissi e retine

Olympic basketball backstops, varnished steel structure projection 225 cm, chipboard backboards on steel frame, fixed rings and nets



S04024 + S04028

ZOOM

S04024

Impianto basket olimpionico a traliccio di acciaio zincato con cassone porta zavorra, mobile con carrello, sbalzo cm 225, tabelloni di resina melamminica su telaio, canestri fissi e retine

Olympic basketball backstops with ballast box, galvanized steel structure projection 225 cm, mobile on trolley, hpl backboards on steel frame, fixed rings and nets

S04026

Impianto basket olimpionico a traliccio di acciaio verniciato con cassone porta zavorra, mobile con carrello, sbalzo cm 225, tabelloni di nobilitato bilaminato su telaio, canestri fissi e retine

Olympic basketball backstops with ballast box, varnished steel structure projection 225 cm, mobile on trolley, chipboard backboards on steel frame, fixed rings and nets

NOTE

Impianti basket **S04022** e **S04026** possono essere verniciati di qualsiasi colore RAL, a richiesta.

*Basketball backstops **S04022** and **S04026** can be varnished in any RAL color, on demand.*

S04028

Coppia protezioni frontali per impianto basket olimpionico
Pair of front protection pads for olympic model basketball backstops

NOTE

Tutti gli impianti basket presenti in questa sezione sono forniti con canestri S04232.

All basketball backstops included in this section are supplied with rings S04232.



S04030



Impianto basket monotubolare di acciaio zincato, struttura con sbalzo cm 225 realizzata in unico elemento, tabelloni di resina melamminica su telaio con tirante di rinforzo, canestri fissi e retine

Monotubular basketball backstops, galvanized steel structure projection 225 cm made of unique element, hpl backboards on steel frame with reinforcing tie bar, fixed rings and nets



S04030



S04032 + S04034



ZOOM

S04032



Impianto basket monotubolare di acciaio zincato, struttura con sbalzo cm 225 realizzata in 2 elementi unibili con viti, tabelloni di resina melamminica su telaio con tiranti di rinforzo, canestri fissi e retine

Monotubular basketball backstops, galvanized steel structure projection 225 cm made of 2 separate elements, hpl backboards on steel frame with reinforcing tie bars, fixed rings and nets



S04034

Coppia protezioni frontali per impianto basket monotubolare S04030 e S04032

Pair of front protection pads for monotubular basketball backstops S04030 and S04032



S04036 + S04037

S04038

Impianto basket monotubolare di acciaio zincato su base con cassone porta zavorra, mobile con carrello, sbalzo cm 165, tabelloni di resina melamminica su telaio con tirante di rinforzo, canestri fissi e retine

Monotubular basketball backstops, galvanized steel structure on base with ballast box, mobile on trolley, projection 165 cm, hpl backboards on steel frame with reinforcing tie bar, fixed rings and nets

S04036 ✓ EN1270 tested

Impianto basket e minibasket monotubolare di acciaio zincato (altezza regolabile manualmente), struttura con sbalzo cm 225, tabelloni di resina melamminica su telaio, canestri fissi e retine

Monotubular basketball and mini-basketball backstops (height manually adjustable), galvanized steel structure projection 225 cm, hpl backboards on steel frame, fixed rings and nets

S04037

Coppia protezioni frontali per impianto basket monotubolare S04036

Pair of front protection pads for monotubular basketball backstops S04036



S04038

NOTE

Gli impianti basket **S04030**, **S04032** e **S04036** possono essere realizzati anche con sbalzo diverso e forniti con tabelloni in plexiglas e canestri reclinabili, a richiesta.

*Basketball backstops **S04030**, **S04032** and **S04036** can be produced with different projection and supplied with acrylic glass backboards and reclining rings, on demand.*

S04040

Coppia protezioni frontali per impianto pallacanestro S04038. Pannello di legno imbottito e rivestito di PVC lavabile, forma triangolare con altezza cm 200. Fissaggio a mezzo viti.

Pair of protective pads for basketball backstops S04038. Padded wooden board covered with PVC fabric, triangular shape, height 200 cm. To be fixed with screws.

S04040



Impianti basket a parete e a soffitto *Wall and roof mounted basketball backstops*



S04056

S04056

Impianto basket a muro con sbalzo cm 185, tabelloni in nobilitato bilaminato su telaio, canestri fissi e retine
Wall mounted basketball backstops, projection 185 cm, chipboard backboards on steel frame, fixed rings and nets

S04058

Impianto basket a muro con sbalzo cm 325, tabelloni in nobilitato bilaminato su telaio, canestri fissi e retine
Wall mounted basketball backstops, projection 325 cm, chipboard backboards on steel frame, fixed rings and nets

NOTE

Gli impianti basket **S04056** e **S04058** possono essere forniti con tabelloni in plexiglas o cristallo e canestri reclinabili, a richiesta.

Basketball backstops S04056 and S04058 can be supplied with acrylic or tempered glass backboards and reclining rings, on demand.

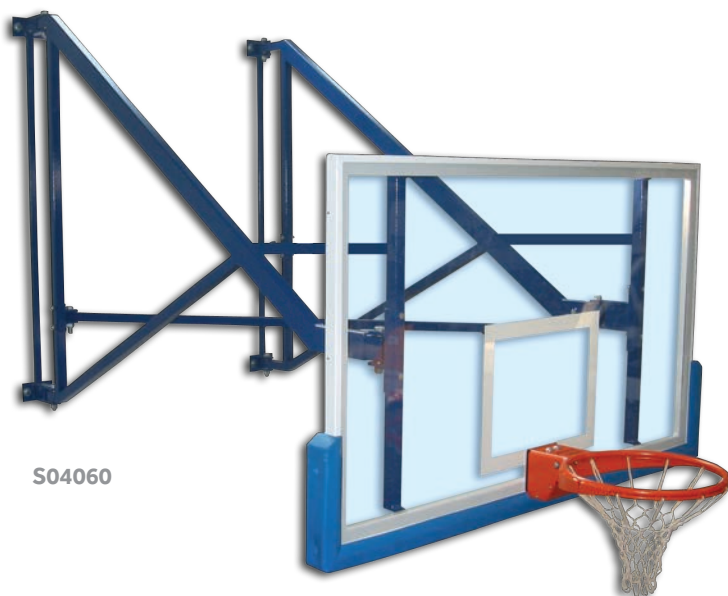

S04060

S04060

Impianto basket a muro chiudibile lateralmente, soluzione economica standard con sbalzo cm 225, tabelloni in cristallo temperato su telaio con protezione, canestri reclinabili e retine
Wall mounted side folding basketball backstops, simple standard construction 225 cm projection, tempered glass backboards on steel frame with pad, reclining rings and nets

S04062

Impianto basket a muro chiudibile lateralmente, soluzione economica standard con sbalzo cm 225, tabelloni in nobilitato bilaminato su telaio, canestri fissi e retine
Wall mounted side folding basketball backstops, simple standard construction 225 cm projection, chipboard backboards on steel frame, fixed rings and nets

Gli impianti basket **S04056**, **S04058**, **S04060**, **S04062**, **S04064** e **S04066** possono essere realizzati anche con sbalzo diverso, a richiesta.

Basketball backstops S04056, S04058, S04060, S04062, S04064 and S04066 can be produced with different projection, on demand.

NOTE



level 2



S04064
Posizione di chiusura
Closed at side



S04064
Posizione minibasket
Mini-basket position

S04064

Impianto basket Trevi a muro chiudibile lateralmente, sbalzo cm 325, tabelloni in cristallo temperato su telaio con protezione, canestri reclinabili e retine; omologato FIBA per competizioni di 2° livello

Wall mounted side folding basketball backstops Trevi, 325 cm projection, tempered glass backboards on steel frame with pad, reclining rings and nets; FIBA approved for 2nd level competitions

S04066

Impianto basket Trevi a muro chiudibile lateralmente, sbalzo cm 325, tabelloni in nobilitato bilaminato su telaio, canestri fissi e retine

Wall mounted side folding basketball backstops Trevi, 325 cm projection, chipboard backboards on steel frame, fixed rings and nets

S04067

Kit motorizzazione impianto basket Trevi a muro chiudibile lateralmente (S04064, S04066)

Kit for motorizing the pair of wall mounted side folding basketball backstops (S04064, S04066)

NOTE

Gli impianti basket **S04064** e **S04066** possono essere forniti, a richiesta, con motorizzazione **S04067** per la gestione del movimento di apertura e chiusura.

*Wall mounted side folding basketball backstops **S04064** and **S04066** can be equipped, on demand, with **S04067** motorization for opening and closing.*





S04070
Chiusura posteriore
Backward closure

S04070 ✓ EN1270 tested

Impianto basket Top a soffitto chiudibile frontalmente o posteriormente verso l'alto, motorizzato, struttura realizzata a disegno, tabelloni in cristallo temperato su telaio con protezione, canestri reclinabili e retine; omologato FIBA per competizioni di 2° livello
Roof mounted forward or backward up folding motorized basketball backstops Top, customized construction, tempered glass backboards on steel frame with pad, reclining rings and nets; FIBA approved for 2nd level competitions



level 2

S04074

Coppia dispositivi meccanici in acciaio verniciato per regolazione dell'altezza dei tabelloni degli impianti basket a muro e a soffitto (basket e minibasket)

Pair of mechanical devices for adjusting backboards' height on wall and roof mounted basketball backstops (basket and mini-basket)

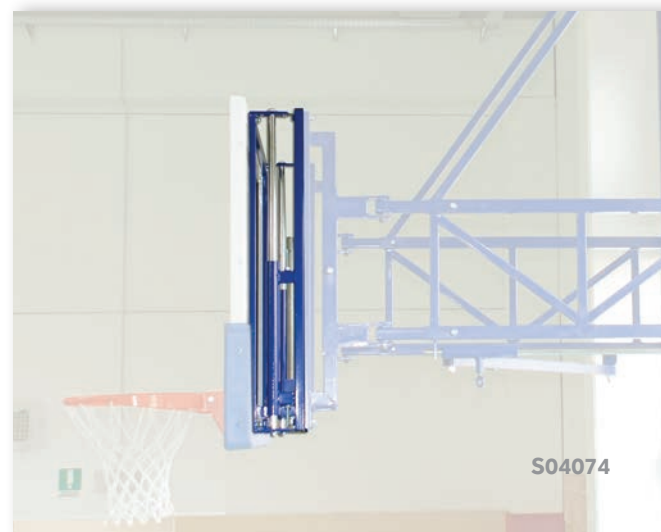

S04074

Video dimostrativo del funzionamento del dispositivo minibasket **S04074** disponibile al sito www.sportssystem.it nella sezione **filmati**.

*Demonstrative video concerning usage of adjusting device **S04074** available at www.sportssystem.it in movies section.*

S04076

Dispositivo anticaduta di sicurezza per impianti basket S04070, a norma DIN EN 360

Crash protection device for basketball backstops S04070, accordingly to DIN EN 360 standard



Impianti basket mobili su ruote Portable basketball backstops

NOTE



Sport System presenta una completa linea di impianti basket omologati FIBA per competizioni internazionali (1° livello), frutto di oltre 40 anni di esperienza maturata nella progettazione e realizzazione di attrezzature per il basket e della fattiva partecipazione nel centro studi FIBA "Equipment and Venue" (già "FIBA research and study centre").

Sport System presents a complete line of portable basketball backstops FIBA approved for International competitions (1st level), that have been developed as a result of company's more than 40 years experience in designing and manufacturing basketball equipment along with the active participation in the FIBA "Equipment and Venue" centre (former "FIBA research and study centre").

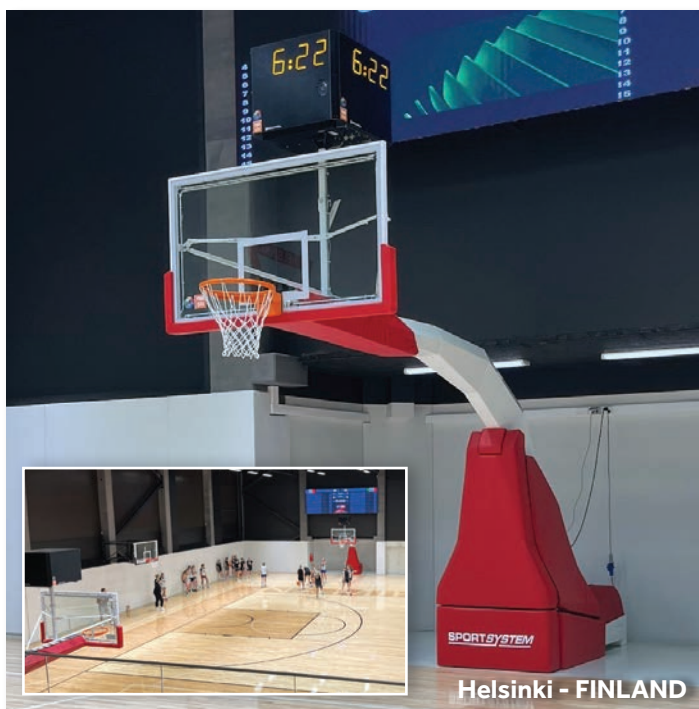



level 1

S04100

Impianto Hydroplay ACE mobile su ruote, sbalzo cm 325, sistema oleodinamico elettrico di regolazione dell'altezza e per la gestione indipendente delle ruote, tabelloni di cristallo temperato con protezione, canestri reclinabili e retine; omologato FIBA per competizioni di 1° livello

Hydroplay ACE portable basketball backstops mobile on wheels, projection 325 cm, oleodynamic electric device for height adjustment and independent control of transport wheels, glass backboards with pad, reclining rings with net; FIBA approved for 1st level competitions

**NOTE**

Gli impianti basket delle linee **Hydroplay** e **Easyplay** sono personalizzabili nella scelta dei colori, a richiesta.

*Portable basketball backstops of **Hydroplay** and **Easyplay** lines can be customized on colors combination, on demand.*



S04102**NEW**

Impianto Hydroplay REX mobile su ruote, sbalzo cm 325, sistema oleodinamico elettrico di regolazione dell'altezza e per la gestione delle ruote, tabelloni di cristallo temperato con protezione, canestri reclinabili e retine; omologato FIBA per competizioni di 1° livello

Hydroplay REX portable basketball backstops mobile on wheels, projection 325 cm, oleodynamic electric device for height adjustment and control of wheels, glass backboards with pad, reclining rings with net; FIBA approved for 1st level competitions



S04102



level 1

S04103

Impianto Hydroplay 2.0 mobile su ruote, sbalzo cm 325, sistema oleodinamico elettrico di regolazione dell'altezza con dispositivi elettronici di bloccaggio alla quota basket o minibasket, tabelloni in cristallo temperato con protezione, canestri reclinabili e retine; omologato FIBA per competizioni di 1° livello

Hydroplay 2.0 portable basketball backstops mobile on wheels, projection 325 cm, oleodynamic electric height adjustment with electronic devices to stop movement both at basket and mini-basket standard, glass backboards with pad, reclining rings with net; FIBA approved for 1st level competitions



S04103



level 1

S04106

Impianto Hydroplay Official mobile su ruote, sbalzo cm 325, sistema oleodinamico manuale di regolazione dell'altezza, tabelloni di cristallo temperato con protezione, canestri reclinabili e retine; omologato FIBA per competizioni di 1° livello

Hydroplay Official portable basketball backstops mobile on wheels, projection 325 cm, oleodynamic manual height adjustment, glass backboards with pad, reclining rings with net; FIBA approved for 1st level competitions



S04106 - S04108

S04108

Impianto Hydroplay Official mobile su ruote, come S04106 ma oleodinamico elettrico

Hydroplay Official portable basketball backstops, like S04106 with oleodynamic electric height adjustment



Video dimostrativi del funzionamento degli impianti basket delle linee Hydroplay e Easyplay disponibili al sito sportsystem.it nella sezione **filmati.**

Demonstrative videos about the usage of portable basketball backstops of Hydroplay and Easyplay lines available at sportsystem.it in movies section.



S04110

S04110

Impianto Easyplay Official mobile su ruote, sbalzo cm 325, sistema meccanico a contrappeso di regolazione dell'altezza, tabelloni di cristallo temperato con protezione, canestri reclinabili e retine; omologato FIBA per competizioni di 1° livello

Easyplay Official portable basketball backstops mobile on wheels, projection 325 cm, mechanical counterweight height adjustment, glass backboards with pad, reclining rings with net; FIBA approved for 1st level competitions

S04111

Impianto Hydroplay ACE mobile su ruote, sbalzo cm 225, sistema oleodinamico manuale di regolazione dell'altezza, tabelloni di cristallo temperato con protezione, canestri reclinabili e retine
Hydroplay ACE portable basketball backstops mobile on wheels, projection 225 cm, oleodynamic manual height adjustment, glass backboards with pad, reclining rings with net



S04111

NOTE

Gli impianti basket delle linee **Hydroplay** e **Easyplay** sono personalizzabili nella scelta dei colori, a richiesta.

Portable basketball backstops of Hydroplay and Easyplay lines can be customized on colors combination, on demand.



level 2

S04113

Impianto Easyplay Training mobile su ruote, sbalzo cm 225, sistema meccanico a contrappeso di regolazione dell'altezza, tabelloni di cristallo temperato con protezione, canestri reclinabili e retine; omologato FIBA per competizioni di 2° livello

Easyplay Training portable basketball backstops mobile on wheels, projection 225 cm, mechanical counterweight height adjustment, glass backboards with pad, reclining rings with net; FIBA approved for 2nd level competitions



S04113





S04114 - S04116

**S04114**

Impianto Hydroplay Training mobile su ruote, sbalzo cm 225, sistema oleodinamico manuale di regolazione dell'altezza, tabelloni di cristallo temperato con protezione, canestri reclinabili e retine
Hydroplay Training portable basketball backstops mobile on wheels, projection 225 cm, oleodynamic manual height adjustment, glass backboards with pad, reclining rings with net

S04116

Impianto Hydroplay Training mobile su ruote, come S04114 ma oleodinamico elettrico
Hydroplay Training portable basketball backstops, like S04114 with oleodynamic electric height adjustment

S04115

Impianto Hydroplay Training mobile su ruote, sbalzo cm 325, sistema oleodinamico manuale di regolazione dell'altezza, tabelloni di cristallo temperato con protezione, canestri reclinabili e retine
Hydroplay Training portable basketball backstops mobile on wheels, projection 325 cm, oleodynamic manual height adjustment, glass backboards with pad, reclining rings with net



S04115 - S04117

**S04117**

Impianto Hydroplay Training mobile su ruote, come S04115 ma oleodinamico elettrico
Hydroplay Training portable basketball backstops, like S04115 with oleodynamic electric height adjustment



level 2



S04118 - S04120

S04118

Impianto Hydroplay Club mobile su ruote, sbalzo cm 225, sistema oleodinamico manuale di regolazione dell'altezza, tabelloni di cristallo temperato con protezione, canestri reclinabili e retine; omologato FIBA per competizioni di 2° livello

Hydroplay Club portable basketball backstops mobile on wheels, projection 225 cm, oleodynamic manual height adjustment, glass backboards with pad, reclining rings with net; FIBA approved for 2nd level competitions

S04120

Impianto Hydroplay Club mobile su ruote, come S04118 ma oleodinamico elettrico

Hydroplay Club portable basketball backstops, like S04118 with oleodynamic electric height adjustment

NOTE

Gli impianti basket con sbalzo standard cm 225 possono essere realizzati con sbalzo cm 275 o diverso, a richiesta.

Portable basketball backstops with standard projection 225 cm can be produced with projection 275 cm or different, on demand.



S04121

S04121

Impianto Easyplay Club mobile su ruote, sbalzo cm 225, sistema di movimentazione a molle, tabelloni di cristallo temperato con protezione, canestri reclinabili e retine

Easyplay Club portable basketball backstops mobile on wheels, projection 225 cm, springs assisted height adjustment, glass backboards with pad, reclining rings with net

S04124

✓ EN1270 tested

Impianto Easyplay College mobile su ruote, sbalzo cm 125, sistema meccanico a manovella di regolazione dell'altezza, tabelloni di nobilitato bilaminato, canestri fissi e retine

Easyplay College portable basketball backstops mobile on wheels, projection 125 cm, mechanical height adjustment, chipboard backboards, fixed rings with net



S04124

NOTE

L'impianto basket **S04124** può essere fornito con tabelloni in plexiglas trasparente completi di protezione (**S04206**), canestri reclinabili (**S04234**) con retina e protezioni laterali della base, a richiesta.

*Basketball backstops **S04124** can be equipped as well with transparent acrylic backboards with pad (**S04206**), reclining rings (**S04234**) with net and soft cushions on sides of the base, on demand.*

**S04126**

Coppia supporti pieghevoli in acciaio verniciato per indicatori elettronici 24", adattabili ad impianti basket Hydroplay e Easyplay
Pair of varnished steel foldable supports for 24" electronic shot clocks to be installed on Hydroplay and Easyplay backstops



S04126



S04129

S04129

Contenitore porta zavorra aggiuntiva in acciaio verniciato con copertura in PVC, applicabile a tutti gli impianti mobili su ruote. Capienza 4 blocchi S04130

Extra ballast container made of varnished steel with PVC cover, to be applied on back side of any portable basketball backstops. Capacity 4 cubes S04130

**NOTE**

Esempi di personalizzazione dei supporti **S04126** in funzione del modello di indicatore 24" in uso e del tipo di impianto basket mobile su ruote.

*Examples of customization of supports **S04126** depending on model of 24" shot clocks and type of portable basketball backstops.*



S04130

S04130

Blocco zavorra per impianti basket mobili, in cemento, peso kg 50

Concrete ballast cube for portable basketball backstop, weight 50 kg

4

Impianti minibasket Mini-basket backstops

S04150



S04150

Impianto minibasket a muro su struttura regolabile in altezza, tabelloni in polipropilene, canestri fissi e retine
Wall mounted mini-basket backstops on height adjustable construction, polypropylene backboards, fixed rings with nets

S04151



S04151

Impianto minibasket a muro, sbalzo cm 80 su singolo tubolare di acciaio verniciato, tabelloni in nobilitato bilaminato, canestri fissi e retine
Wall mounted mini-basket backstops on single 80 cm projection arm in varnished steel, chipboard backboards, fixed rings and nets

S04152



S04152

Impianto minibasket a muro, struttura in acciaio verniciato, con sbalzo cm 185, tabelloni di nobilitato bilaminato, canestri fissi e retine
Wall mounted mini-basket backstops, varnished steel structure units, projection 185 cm, chipboard backboards, fixed rings and nets



S04154

S04154

Impianto minibasket a traliccio di acciaio zincato, sbalzo cm 145, tabelloni di resina melamminica, canestri fissi e retine
Galvanized steel mini-basket backstops, projection 145 cm, hpl backboards, fixed rings and nets



S04156 - ZOOM

S04156

Impianto minibasket a traliccio di acciaio zincato mobile con carrello su ruote, sbalzo cm 145, cassoni porta zavorra, tabelloni di resina melamminica, canestri fissi e retine
Galvanized steel mini-basket backstops mobile with trolley, with ballast boxes, projection 145 cm, hpl backboards, fixed rings and nets



S04158

S04158

Coppia protezioni frontali per impianto minibasket a traliccio S04154 e S04156
Pair of front protection pads for mini-basket backstops S04154 and S04156

NOTE

Tutti gli impianti minibasket presenti in questa sezione sono forniti con canestri S04230.

All mini-basket backstops included in this section are supplied with rings S04230.

**S04159**

Impianto minibasket monotubolare di acciaio zincato, sbalzo cm 165, tabelloni di resina melamminica, canestri fissi e retine
Galvanized steel monotubular mini-basket backstops, projection 165 cm, hpl backboards, fixed rings and nets

S04160

Coppia protezioni frontali per impianto minibasket monotubolare S04159
Pair of front protection pads for monotubular mini-basket backstops S04159

**S04161**

Coppia strutture minibasket in acciaio verniciato agganciabili a tabellone basket, complete di tabellone in nobilitato bilaminato, canestro fisso e retina
Pair of mini-basket varnished steel constructions to be attached to basketball backboard, including chipboard backboards, fixed rings and nets

S04162

Carrello in acciaio verniciato, mobile su ruote, per sollevamento strutture minibasket agganciabili S04161
Varnished steel trolley, mobile on wheels, lifting the mini-basket constructions S04161

5

Tabelloni basket e minibasket, protezioni, canestri, retine

Basket and mini-basket backboards, protective pads, rings, nets



S04202 - S04204

S04202

Tabellone basket di nobilitato bilaminato per interno, dimensioni mm 1800x1050x18

Chipboard basketball backboard for indoor use, dimensions 1800x1050x18 mm

S04204

Tabellone basket di resina melamminica per esterno, dimensioni mm 1800x1050x10

Hpl basketball backboard for outdoor use, dimensions 1800x1050x10 mm

S04205

Tabellone basket di vetroresina con anima in legno per uso interno ed esterno, dimensioni mm 1800x1050x30

Wooden core fibreglass covered basketball backboard for indoor and outdoor use, dimensions 1800x1050x30 mm

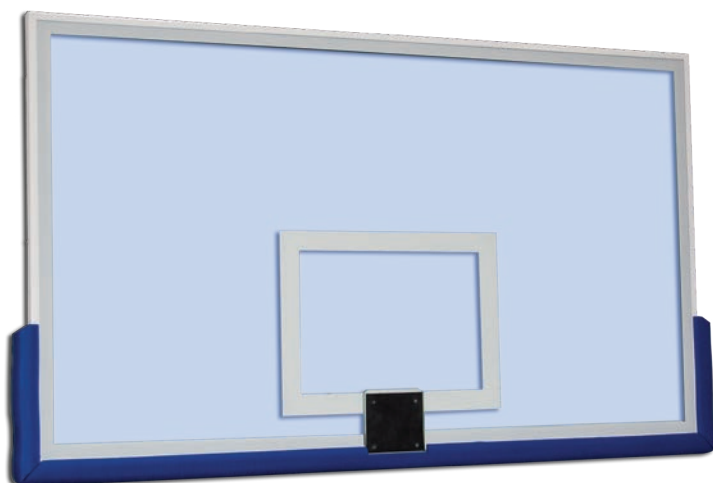

S04206 - S04208

S04206

Tabellone basket di plexiglas trasparente, dimensioni mm 1800x1050x15 con risega, su telaio in acciaio verniciato con protezione S04222

Transparent acrylic glass basketball backboard, dimensions 1800x1050x15 mm with ring cutout, mounted onto varnished steel frame with pad S04222

S04208

Tabellone basket di cristallo temperato con pellicola di sicurezza, dimensioni mm 1800x1050x12 con risega, su telaio in acciaio verniciato con protezione S04222

Safety tempered glass basketball backboard with protective film, dimensions 1800x1050x12 mm with ring cutout, mounted onto varnished steel frame with pad S04222

S04210

Tabellone basket di cristallo temperato con pellicola di sicurezza, dimensioni mm 1800x1050x12 con risega, su telaio in acciaio verniciato con protezione S04224

Safety tempered glass basketball backboard with protective film, dimensions 1800x1050x12 mm with ring cutout, mounted onto varnished steel frame with pad S04224

S04214

Tabellone minibasket di nobilitato bilaminato per interno, dimensioni mm 1200x900x18

Chipboard mini-basket backboard for indoor use, dimensions 1200x900x18 mm



S04214 - S04216

S04216

Tabellone minibasket di resina melamminica per esterno, dimensioni mm 1200x900x10

Hpl mini-basket backboard for outdoor use, dimensions 1200x900x10 mm

S04218

Telaio di acciaio verniciato per supporto tabellone basket
Varnished steel frame supporting basketball backboard

S04220

Telaio di acciaio verniciato per supporto tabellone minibasket
Varnished steel frame supporting mini-basket backboard

S04221

**S04221**

Carrello in acciaio verniciato funzionale allo stoccaggio, alla movimentazione ed all'installazione di tabelloni su impianti basket mobili su ruote
Varnished steel trolley useful to storage, transport and install backboard on portable basketball backstops

S04226



S04222



ZOOM

S04222

Protezione di poliuretano da applicare con viti su telaio tabellone basket, modello ad L
Polyurethane basketball backboard pad to be fixed with screws, L shaped model



S04224

S04224

Protezione di poliuretano da applicare con viti su telaio tabellone basket, modello ad U secondo norme FIBA
Polyurethane basketball backboard pad to be fixed with screws, U shaped model accordingly to FIBA rules

S04226

Per-Light, cornice luminosa a led di colore rosso più segmento a led di colore giallo da applicare sul tabellone basket in cristallo, con centralina di comando per collegamento ad indicatore 24"
Per-Light, set of red led perimeter plus yellow led segment to be installed on glass basketball backboard, complete of control unit for connection to 24" shot clock

Le protezioni di poliuretano **S04224** sono disponibili in colore **blu**, **nero** e **rosso**;
 per ordini di minimo 50 pezzi possono essere prodotte in qualsiasi altro colore, a richiesta.

NOTE

*Polyurethane pads **S04224** are available in **blue**, **black** and **red** colors; for orders of minimum 50 pieces can be produced of any other different color, on demand.*

**S04228**

Canestro regolamentare in acciaio verniciato
Standard varnished steel basketball ring

**S04230****NEW**

Canestro regolamentare in acciaio verniciato, modello pesante
Standard varnished steel basketball ring, heavy model

**S04232**

✓ EN1270 tested

Canestro regolamentare super rinforzato in acciaio verniciato a norma EN1270
Standard varnished steel basketball ring, heavy reinforced model accordingly to EN1270

**S04234**

✓ EN1270 tested

Canestro regolamentare reclinabile in acciaio verniciato a norma EN1270
Reclining varnished steel basketball ring accordingly to EN1270

**S04235**

Canestro regolamentare reclinabile in acciaio zincato a norma EN1270
Reclining galvanized steel basketball ring accordingly to EN1270

**S04236**

✓ EN1270 tested

Canestro regolamentare reclinabile in tubo pieno di acciaio verniciato a norma EN1270, fissaggio retina senza ganci
Reclining varnished steel basketball ring, reinforced model accordingly to EN1270, net fixation without hooks

**S04237**

✓ EN1270 tested

Canestro regolamentare reclinabile in 3 direzioni (anche lateralmente) in tubo pieno di acciaio verniciato a norma EN1270, fissaggio retina senza ganci
Three directions reclining varnished steel basketball ring, reinforced model accordingly to EN1270, net fixation without hooks

**S04238**

Canestro regolamentare in acciaio zincato per esterno
Standard galvanized steel basketball ring for outdoor use



S04240

S04240

Retina basket regolamentare di nylon
Nylon cord basketball net



S04241

S04241

Retina basket regolamentare di nylon plastificato, anti-attorcigliamento
Plastified nylon cord basketball net, anti-whip



S04244

S04244

Retina basket regolamentare di cotone
Cotton cord basketball net



S04246

S04246

Retina basket di acciaio zincato per esterno
Galvanized steel basketball net for outdoor use

NOTE



winner of
Women's Club World Champs
CEU Women's Champions League
Women's Club Italian Champs



Fornitore ufficiale - Official supplier: Imoco Volley Conegliano - serie A1

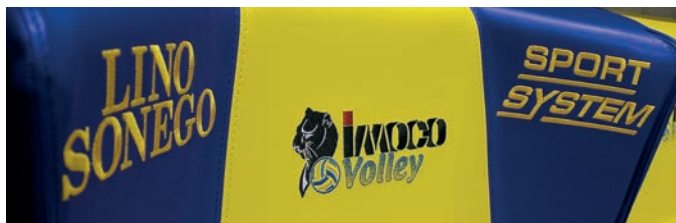

NOTE

Sedute vip "Sport System by Lino Sonego" per riserve ed allenatori

Un tocco di stile italiano a bordo campo!

In alternativa alle più tradizionali panchine per le riserve e gli allenatori Sport System offre, anche per i palazzetti multi sport indoor, la possibilità di attrezzare le aree tecniche delle due squadre con poltrone VIP totalmente personalizzabili nella scelta del modello, dei colori e dell'eventuale logo da ricamare.

Per maggiori informazioni e per richiedere un preventivo contattare info@sportssystem.it

VIP armchairs "Sport System by Lino Sonego" for substitute players and coaches

A touch of Italian style on courtside!

As an alternative to the traditional substitute benches Sport System offers, even for indoor multi sport arenas, the option of upgrading both two teams' technical areas with luxury VIP armchairs. These can be customized with any colours and logos. The logos are permanently embroidered.

For further information or samples contact info@sportssystem.it



6

Panchine per giocatori, tavoli giuria, accessori
Players benches, judges tables, accessories

**S04252**

Poltrona per riserve ed allenatori in pelle sintetica su supporto mobile in acciaio verniciato. Disponibile in vari modelli. Personalizzabile nei colori e con ricamo loghi (vedi pagina 86)

High comfort luxury armchair for players and coach covered by synthetic leather to be customized with colours and logos, mounted onto steel support. Available in different models (refer to page 86)

S04254**S04254**

Panca per riserve ed allenatori con poggiaschiena, struttura di acciaio verniciato, doghe di legno, lunghezza cm 300

Players and coach bench with backrest, varnished steel structure, wooden seating area, length 300 cm

**S04256****S04256**

Tavolo per giuria con struttura di acciaio verniciato e piano di legno, dimensioni cm 160x80x76

Judges table with varnished steel structure and wooden top, dimensions 160x80x76 cm



S04260

S04260

Tavolo per giuria con struttura di acciaio verniciato e carenatura di legno, dimensioni cm 300x70x76, mobile su ruote

Judges table with varnished steel structure, wooden top and sides, dimensions 300x70x76 cm, mobile on wheels

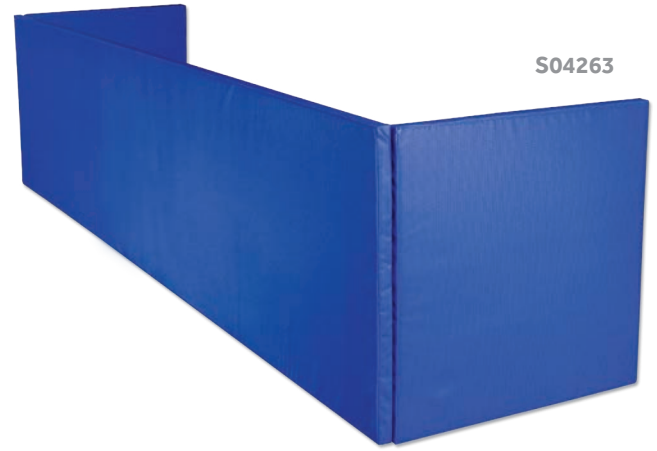

S04263

S04263

Imbottitura per tavolo giuria mt 3, S04260 e S04262

Soft pad for judges table with length of 3 mt, S04260 and S04262



S04262

**S04262**

Tavolo per giuria con struttura di acciaio verniciato e carenatura di legno, pedana ribaltabile per contenimento oggetti, dimensioni cm 300x70x76, mobile su ruote

Judges table with varnished steel structure, wooden top and sides, closing platform for storing accessories, dimensions 300x70x76 cm, mobile on wheels



S04264

**S04264**

Tavolo per giuria modello FIBA mobile su ruote, frontale imbottito e rivestito, completo di sgabelli cambio giocatori ai lati, dimensioni totali cm 515x95x90

Judges table FIBA model mobile on wheels, padded and covered front panel, wooden top, including players substitution stools, total dimensions 515x95x90 cm



S04266

**S04266**

Protezione mobile su ruote per tavolo giuria e panche per riserve ed allenatori, struttura in acciaio verniciato, pannellatura in policarbonato trasparente

Protective screen for judges table or players and coach benches, varnished steel structure and transparent polycarbonate panel, mobile on wheels



S04268

S04268

Sedia per giudici in polipropilene colorato con struttura di acciaio cromato

Judge chair made of coloured polypropylene with chromed steel structure



S04270

S04270

Sgabello di legno per cambio giocatori

Wooden stool for player substitution

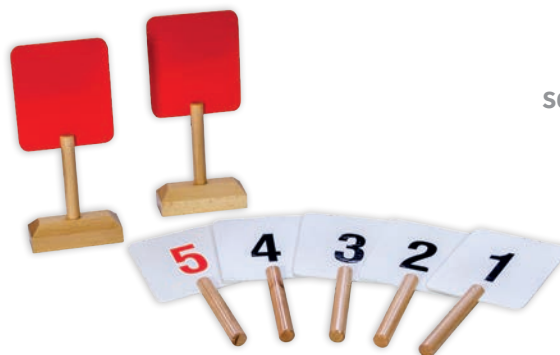

S04272

S04272

Serie palette in legno per indicazione manuale dei falli di squadra, compresi supporti

Set of wooden plates with supports for manual indication of teams' fouls



S04274

S04274

Serie palette in legno per indicazione manuale dei 24 secondi

Set of wooden plates for manual indication of 24 seconds

**S04276**

Cronometro contasecondi per tavolo giudici

Stopwatch chronometer for judges table

**S04277**

Cronometro contasecondi per tavolo giudici, digitale

Digital stopwatch chronometer for judges table

S04278

**S04278**

Segnapunti manuale da tavolo per basket

Portable desk manual scoreboard for basketball



S04280

S04280

Segnapunti manuale a 6 cifre (3+3) su struttura girevole con base in acciaio verniciato
Manual scoreboard with 6 digits (3+3) on revolving varnished steel structure with base



S04286

S04286

Lavagna magnetica per basket con pedine, dimensioni cm 85x60
Magnetic tactic board for basketball, dimensions 85x60 cm



S04288

S04288

Dispositivo manuale di indicazione possesso palla
Manual alternating possession arrow



S04282

S04282

Segnapunti manuale a 6 cifre (3+3) su struttura in acciaio verniciato da fissare a parete
Manual scoreboard with 6 digits (3+3) on varnished steel frame to be fixed to the wall



S04290

S04290

Dispositivo elettronico di indicazione possesso palla, secondo disposizioni FIBA, dimensioni cm 60x25x5
Electronic alternating possession arrow, in accordance with FIBA rules, dimensions 60x25x5 cm

S04284

**S04284**

Tabella di ricambio per segnapunti manuale, colore rosso o nero
Replacement digit panel for manual scoreboard, red or black colour



S04292

S04292

Misuratore di alluminio per verifica altezza canestro
Aluminium height measurer device for ring's height

Articoli allenamento basket Training accessories for basket

S04293

Macchina spara palloni Dr Dish
modello Rebel (livello base)
*Dr Dish balls shooting machine for
basket, model Rebel (entry level)*



S04294

Macchina spara palloni Dr Dish
modello All Star (livello medio)
*Dr Dish balls shooting machine for
basket, model All Star (medium level)*



S04295

Macchina spara palloni Dr Dish
modello CT (livello top)
*Dr Dish balls shooting machine for
basket, model CT (top level)*



S04296

Raccoglitore di palloni Dr Dish IC3 applicabile a
qualsiasi impianto basket
*Dr Dish IC3 shot trainer rebounder suitable for all
different models of basketball backstop*

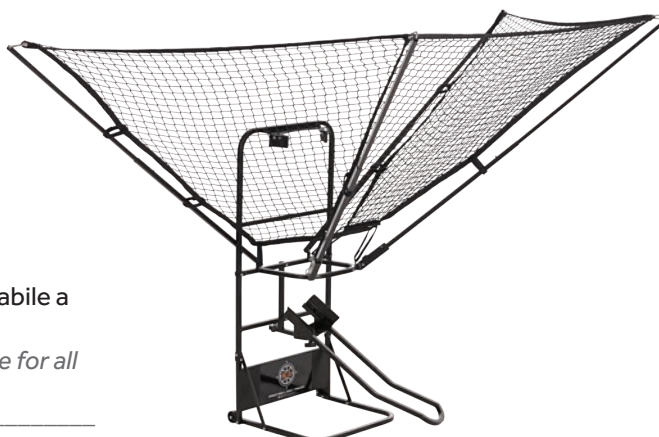

**S04297**

Sagoma in posizione difensiva per allenamento gioco basket con base auto stabile

Portable hands-up mannequin for basket with self-standing base

S04298

Dribble Stick SKLZ funzionale a diverse sessioni di allenamento con la palla

Dribble stick SKLZ suitable for several different training exercises with ball

**S04299**

Telaio con rete Solo Assist per simulazione assist ed allenamento al passaggio

Solo Assist rebounder frame suitable for training on assist and catching the ball

8

Porte calcio e calcio ridotto, accessori Standard and reduced soccer goals, accessories



S04302 ✓ EN748 tested

Coppia porte calcio regolamentari in alluminio, sezione ovale mm 120x100, modello a bussole con pali reggirete distanziati, traversa divisa

Pair of aluminium standard soccer goals, oval section 120x100 mm, ground sockets to be buried and free hanging net supports, crossbar in two sections



S04306 ✓ EN748 tested

Coppia porte calcio regolamentari in alluminio, sezione ovale mm 120x100, modello mobile con base, traversa divisa

Pair of aluminium standard soccer goals, oval section 120x100 mm, portable freestanding model with ground base, crossbar in two sections



S04303 ✓ EN748 tested

Coppia porte calcio regolamentari in alluminio, sezione ovale mm 120x100, modello a bussole con reggirete a gomito, traversa divisa

Pair of aluminium standard soccer goals, oval section 120x100 mm, ground sockets to be buried and curved net supports, crossbar in two sections



S04307 ✓ EN748 tested

Coppia porte calcio regolamentari in alluminio, modello mobile con base, interamente realizzate con profilo a sezione ovale mm 120x100, traversa divisa

Pair of aluminium standard soccer goals, portable freestanding model with ground base, entirely realized with oval section profiles 120x100 mm, crossbar in two section

S04304 ✓ EN748 tested

Coppia porte calcio come articolo S04302 - traversa intera
Pair of aluminium standard soccer goals as S04302 - entire crossbar

S04308 ✓ EN748 tested

Coppia porte calcio come articolo S04306 - traversa intera
Pair of aluminium standard soccer goals as S04306 - entire crossbar

S04305 ✓ EN748 tested

Coppia porte calcio come articolo S04303 - traversa intera
Pair of aluminium standard soccer goals as S04303 - entire crossbar

S04309 ✓ EN748 tested

Coppia porte calcio come articolo S04307 - traversa intera
Pair of aluminium standard soccer goals as S04307 - entire crossbar



S04310

S04310 ✓ EN16579 tested

Coppia porte calcio a 7 in alluminio, dimensioni cm 600x200, sezione ovale mm 120x100, modello mobile con base
Pair of aluminium goals for 7 a side soccer, dimensions 600x200 cm, oval section 120x100 mm, portable freestanding model with ground base

S04311

Coppia porte calcio a 7 in alluminio, dimensioni cm 600x200, sezione ovale mm 120x100, modello a bussole con reggirete a gomito
Pair of aluminium goals for 7 a side soccer, dimensions 600x200 cm, oval section 120x100 mm, ground sockets model with curved net supports

S04312

Coppia porte calcio a 7 in alluminio, dimensioni cm 600x200, sezione mm 80, modello mobile con base
Pair of aluminium goals for 7 a side soccer, dimensions 600x200 cm, round section diameter 80 mm, portable freestanding model with ground base

S04314

Coppia porte calcio a 7 in acciaio, dimensioni cm 600x200, sezione mm 80, modello mobile con base
Pair of steel goals for 7 a side soccer, dimensions 600x200 cm, round section diameter 80 mm, portable freestanding model with ground base

S04316 ✓ EN748 tested

Coppia porte calcio ridotto in alluminio, dimensioni cm 500x200, sezione ovale mm 120x100, modello mobile con base
Pair of aluminium reduced goals for soccer, dimensions 500x200 cm, oval section 120x100 mm, portable freestanding model with ground base

S04317 ✓ EN748 tested

Coppia porte calcio ridotto in alluminio, dimensioni cm 500x200, sezione ovale mm 120x100, modello a bussole con reggirete a gomito
Pair of aluminium reduced goals for soccer, dimensions 500x200 cm, oval section 120x100 mm, ground sockets model with curved net supports



S04318

S04318 ✓ EN16579 tested

Coppia porte calcio ridotto in alluminio, dimensioni cm 500x200, sezione mm 80, modello mobile con base
Pair of aluminium reduced goals for soccer, dimensions 500x200 cm, round section diameter 80 mm, portable freestanding model with ground base



S04320

S04320 ✓ EN748 tested

Coppia porte calcio ridotto in acciaio, dimensioni cm 500x200, sezione mm 80, modello mobile con base
Pair of steel reduced goals for soccer, dimensions 500x200 cm, round section diameter 80 mm, portable freestanding model with ground base

S04322 ✓ EN16579 tested

Coppia porte calcio ridotto in alluminio, dimensioni cm 400x200, sezione ovale mm 120x100, modello mobile con base
Pair of aluminium reduced goals for soccer, dimensions 400x200 cm, oval section 120x100 mm, portable freestanding model with ground base

S04323 ✓ EN16579 tested

Coppia porte calcio ridotto in alluminio, dimensioni cm 400x200, sezione ovale mm 120x100, modello a bussole con reggirete a gomito
Pair of aluminium reduced goals for soccer, dimensions 400x200 cm, oval section 120x100 mm, ground sockets model with curved net supports

S04324 ✓ EN16579 tested

Coppia porte calcio ridotto in alluminio, dimensioni cm 400x200, sezione mm 80, modello mobile con base
Pair of aluminium reduced goals for soccer, dimensions 400x200 cm, round section diameter 80 mm, portable freestanding model with ground base

S04326

Coppia porte calcio ridotto in acciaio, dimensioni cm 400x200, sezione mm 80, modello mobile con base
Pair of steel reduced goals for soccer, dimensions 400x200 cm, round section diameter 80 mm, portable freestanding model with ground base

**S04328**

Coppia telai fissi a terra, in acciaio zincato, per porte calcio regolamentari a bussole
Pair of fixed ground frames made of galvanized steel, for standard soccer goals, sockets type

S04330

Coppia dispositivi alza rete, in acciaio zincato, per porte calcio regolamentari a bussole
Pair of foldable ground frames made of galvanized steel for standard soccer goals, sockets type

S04331

Coppia dispositivi alza rete in alluminio con gancetti reggirete in polipropilene, per porte calcio regolamentari a bussole
Pair of foldable ground frames in aluminium with plastic safety net holders for standard soccer goals, sockets type

**S04332**

Coppia ruote gommate con staffa in acciaio per spostamento porte calcio mobili
Pair of rubber inflatable wheels on steel support useful for rolling away portable soccer goals

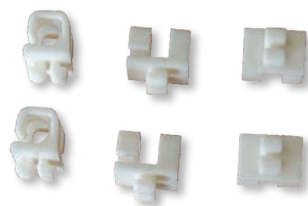
**S04335**

Serie 100 gancetti reggirete in polipropilene con doppio gancio per porte calcio, bloccaggio a pressione
Set of 100 plastic safety net holders with twin hooks for soccer goal, blocking by pressure

**S04336**

Serie 100 gancetti reggirete in polipropilene per porte calcio, bloccaggio a pressione
Set of 100 plastic safety net holders for soccer goal, blocking by pressure

**S04340**

Modulo zavorra per porte calcio, calcio ridotto, pallamano e calcetto composto di due profili in alluminio zavorrabili uniti tra loro
Ballast module for football, reduced football, handball and futsal goals made up of two aluminum profiles joined together, to be filled

**S04342**

Set protezioni per coppia telai a terra fissi (S04328) o ribaltabili (S04330, S04331) composti di elementi soffici e rivestimento in PVC
Set of protection pads for the pair of fixed (S04328) or folding (S04330, S04331) ground frames made of soft elements and PVC covers

S04344

Set protezioni per i 4 pali distanziati posteriori tendi rete per porte calcio a bussole (S04302, S04304) composti di elementi soffici e rivestimento in PVC
Set of protection pads for the 4 rear poles useful for tensioning the net on socket type goals (S04302, S04304) made of soft elements and PVC covers

Reti per porte calcio e calcio ridotto

Nets for standard and reduced soccer goals

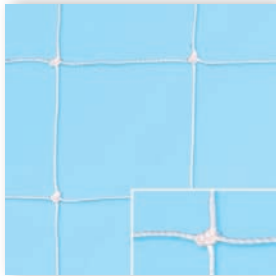
**S04352**

Coppia reti calcio regolamentari in polietilene diametro mm 3, profondità cm 100/200, maglia cm 12x12 con nodo

Pair of nets for standard soccer goals made of polyethylene diameter 3 mm, depth 100/200 cm, knotted mesh 12x12 cm

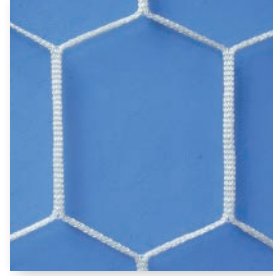
**S04362**

Coppia reti calcio regolamentari in polipropilene diametro mm 4, profondità cm 200/200, maglia esagonale

Pair of nets for standard soccer goals made of polypropylene diameter 4 mm, depth 200/200 cm, hexagonal mesh

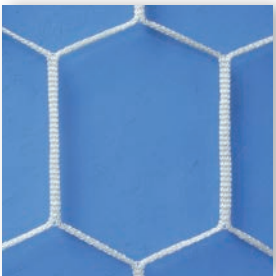
**S04354**

Coppia reti calcio regolamentari in polipropilene diametro mm 5, profondità cm 100/200, maglia esagonale

Pair of nets for standard soccer goals made of polypropylene diameter 5 mm, depth 100/200 cm, hexagonal mesh

**S04364**

Coppia reti calcio regolamentari in nylon diametro mm 5, profondità cm 200/200, maglia cm 10x10, disponibili in vari colori

Pair of nets for standard soccer goals made of nylon diameter 5 mm, depth 200/200 cm, mesh 10x10 cm, available in several colors

**S04356**

Coppia reti calcio regolamentari in polipropilene diametro mm 6, profondità cm 100/200, maglia cm 10x10 senza nodo

Pair of nets for standard soccer goals made of polypropylene diameter 6 mm, depth 100/200 cm, knotless mesh 10x10 cm

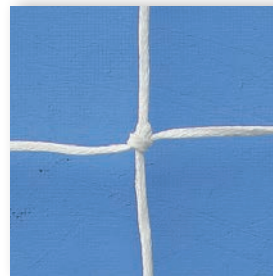
**S04366**

Coppia reti calcio ridotto cm 600x200 in polietilene diametro mm 3,5 con nodo, profondità cm 100/160, maglia cm 14x14

Pair of nets for reduced soccer goals 600x200 cm made of polyethylene diameter 3.5 mm knotted, depth 100/160 cm, square mesh 14x14 cm

**S04358**

Coppia reti calcio regolamentari in nylon diametro mm 6, profondità cm 100/200, maglia esagonale

Pair of nets for standard soccer goals made of nylon diameter 6 mm, depth 100/200 cm, hexagonal mesh

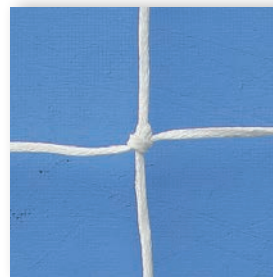
**S04368**

Coppia reti calcio ridotto cm 500x200 in polietilene diametro mm 3,5 con nodo, profondità cm 100/160, maglia cm 14x14

Pair of nets for reduced soccer goals 500x200 cm made of polyethylene diameter 3.5 mm knotted, depth 100/160 cm, square mesh 14x14 cm

**S04360**

Coppia reti calcio regolamentari in polietilene diametro mm 3,5 annodato, profondità cm 200/200, maglia quadra

Pair of nets for standard soccer goals made of polyethylene diameter 3.5 mm knotted, depth 200/200 cm, square mesh

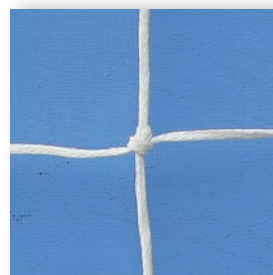
**S04370**

Coppia reti calcio ridotto cm 400x200 in polietilene diametro mm 3,5 con nodo, profondità cm 100/160, maglia cm 14x14

Pair of nets for reduced soccer goals 400x200 cm made of polyethylene diameter 3.5 mm knotted, depth 100/160 cm, square mesh 14x14 cm

10

Panchine per riserve ed allenatori Team shelters



S04402

Panchina riserve e allenatori, struttura di acciaio zincato, pannelli di stratificato e policarbonato alveolare mm 6, sedute a doghe di legno o scocche di polipropilene
Team shelter, galvanized steel construction, hollow cell polycarbonate panels 6 mm, continuous wooden bench or polypropylene seats



S04408

Panchina riserve e allenatori, struttura di alluminio, pannelli di stratificato e policarbonato alveolare mm 6, sedute a doghe di legno o scocche di polipropilene
Team shelter, aluminium construction, hollow cell polycarbonate panels 6 mm, continuous wooden bench or polypropylene seats



S04404

Panchina riserve e allenatori, struttura di acciaio zincato, pannelli di stratificato e policarbonato trasparente mm 3, sedute a doghe di legno o scocche di polipropilene
Team shelter, galvanized steel construction, transparent polycarbonate panels 3 mm, continuous wooden bench or polypropylene seats

S04406

Coppia elementi laterali per panchina riserve e allenatori in acciaio zincato S04402 e S04404, pannelli di stratificato e policarbonato trasparente mm 3
Pair of lateral elements for galvanized steel team shelters S04402 and S04404 with transparent polycarbonate panels



S04410

Panchina riserve e allenatori, struttura di alluminio, pannelli di stratificato e policarbonato trasparente mm 3, sedute a doghe di legno o scocche di polipropilene
Team shelter, aluminium construction, transparent polycarbonate panels 3 mm, continuous wooden bench or polypropylene seats

S04412

Coppia elementi laterali per panchina riserve e allenatori in alluminio S04408 e S04410, pannelli di stratificato e policarbonato trasparente mm 3
Pair of lateral elements for aluminium team shelters S04408 and S04410 with transparent polycarbonate panels



S04414 + S04416

S04414

Panchina riserve e allenatori, struttura di acciaio zincato, pannelli di policarbonato trasparente mm 3, sedute a scocche di polipropilene, protezione parasigoli
Team shelter, galvanized steel construction, transparent polycarbonate panels 3 mm, polypropylene seats, soft corners protection pad

S04418

Panchina riserve e allenatori a doppia profondità, struttura di acciaio zincato, pannelli di policarbonato trasparente mm 3, modulo da mt 2 completo di tribunetta di seduta in acciaio zincato a 2 gradoni con 7 scocche di seduta di polipropilene, protezione parasigoli
Double depth team shelter, galvanized steel construction, transparent polycarbonate panels 3 mm, module of 2 mt complete of 2 steps galvanized steel stand with 7 polypropylene seats, soft corners protection pad

S04420

Coppia elementi laterali per panchina riserve e allenatori a doppia profondità in acciaio zincato S04418, pannelli di policarbonato trasparente mm 3
Pair of lateral elements for double depth galvanized steel team shelters S04418 with transparent polycarbonate panels



S04415 + S04416

S04415

Panchina riserve ed allenatori S04414 su struttura mobile con ruote
Team shelter S04414 on structure mobile with wheels

S04416

Coppia elementi laterali per panchine riserve e allenatori in acciaio zincato S04414 e S04415, pannelli di policarbonato trasparente mm 3
Pair of lateral elements for galvanized steel team shelters S04414 and S04415 with transparent polycarbonate panels



S04418 + S04420



S04422 + S04424

S04422

Panchina riserve e allenatori ad altezza ridotta (cm 165), struttura di acciaio zincato, pannelli di policarbonato trasparente mm 3, sedute a scocche di polipropilene, protezione parasigoli
Reduced height team shelter (165 cm), galvanized steel construction, transparent polycarbonate panels 3 mm, polypropylene seats, soft corners protection pad

S04424

Coppia elementi laterali per panchina riserve e allenatori ad altezza ridotta in acciaio zincato S04422, pannelli di policarbonato trasparente mm 3
Pair of lateral elements for reduced height galvanized steel team shelters S04422 with transparent polycarbonate panels

**S04426**

Panchina riserve e allenatori trasportabile, copertura con struttura di alluminio e pannelli di stratificato e policarbonato trasparente mm 3, pedana in acciaio zincato con superficie di alluminio e ruote girevoli integrate sul fondo, sedute a scocche di polipropilene su struttura in acciaio zincato collegata alla pedana

Portable team shelter, cover construction made of aluminium with hpl and transparent polycarbonate panels 3 mm, galvanized steel platform with aluminium surface and pivoting wheels installed on bottom side, polypropylene seats on galvanized steel structure fixed to the platform

**S04430**

Panchina riserve e allenatori a buca completa di elementi laterali, struttura di acciaio zincato realizzata a disegno, pannelli di policarbonato trasparente mm 3, sedute di polipropilene colorato, protezioni parasigoli

Team shelter with lateral elements to be customized over existing pit, galvanized steel structure, transparent polycarbonate panels 3 mm, polypropylene seats, soft corners protection pads



S04426 + S04428

S04427 + S04428

**S04427**

Panchina riserve ed allenatori S04410 su struttura mobile con ruote

Team shelter S04410 on structure mobile with wheels

S04428

Coppia elementi laterali per panchine riserve e allenatori trasportabili S04426 e S04427, struttura in alluminio con pannelli di stratificato e policarbonato trasparente mm 3

Pair of lateral elements for portable team shelters S04426 and S04427, aluminium construction with hpl and transparent polycarbonate panels

**S04432**

Protezione parasigoli per panchine riserve e allenatori di gomma ad alta densità rivestita di materiale sintetico, applicabile con Velcro

Corner protection pad for team shelter, high density foam covered outside by synthetic material, applicable with Velcro

**S04434**

Modulo di seduta per panchina quarto uomo composto di due scocche in polipropilene colorato con leggìo ribaltabile e piano porta borse su struttura in acciaio zincato

Seating element for soccer referees made of 2 polypropylene seats with tip-up writing boards and bags support table

S04439

**S04439**

Panchina riserve ed allenatori S04440 su struttura mobile con ruote

Team shelter S04440 on structure mobile with wheels



S04440

S04440

Panchina riserve e allenatori completa di elementi laterali, struttura di alluminio, pannelli di stratificato e policarbonato trasparente mm 3, poltrone in ecopelle personalizzabili, protezioni parasigoli

Team shelter with lateral elements, aluminium construction, transparent polycarbonate panels 3 mm, high comfort padded armchairs to be customized, soft corner protection pads

NOTE

Le panchine della presente **linea VIP** sono totalmente personalizzabili dal punto di vista funzionale ed estetico in base alle esigenze del cliente e possono essere fornite con oltre 10 diversi modelli di poltrone VIP.

*Team shelters of **VIP line** can be totally customized under the functional and aesthetic points of view based on customer's requirements and can be supplied with over 10 different models of VIP armchairs.*



S04441

S04441

Panchina riserve ed allenatori S04442 su struttura mobile con ruote.

Team shelter S04442 on structure mobile with wheels



S04442

S04442

Panchina riserve e allenatori completa di elementi laterali, struttura di acciaio zincato, pannelli di policarbonato trasparente mm 3, poltrone in ecopelle personalizzabili, protezione parasigoli

Team shelter with lateral elements, galvanized steel construction, transparent polycarbonate panels 3 mm, high comfort padded armchairs to be customized, soft corner protection pad



S04444

S04444

Panchina riserve e allenatori completa di elementi laterali, struttura di acciaio zincato e verniciato, pannelli di policarbonato ombrato mm 3, pedana in acciaio zincato con superficie di alluminio e ruote girevoli integrate sul fondo, poltrone in ecopelle personalizzabili, protezione parasigoli

Team shelter with lateral elements, galvanized and epoxy painted steel construction, grey polycarbonate panels 3 mm, galvanized steel platform with aluminium surface and pivoting wheels installed on bottom side, high comfort padded armchairs to be customized, soft corner protection pad

S04445

Panchina riserve e allenatori modello "Marrakech", copertura in acciaio zincato con pannelli di policarbonato trasparente mm 3, completa di elementi laterali, su pedana in acciaio zincato con superficie di alluminio e ruote girevoli integrate sul fondo, poltrone in ecopelle personalizzabili, protezione parasigoli. Altezza totale contenuta in soli cm 165

Team shelter model "Marrakech", protective shell made in galvanized steel with transparent polycarbonate panels 3 mm, including lateral elements, mobile on galvanized steel platform with aluminium surface and pivoting wheels on bottom side, high comfort padded armchairs to be customized, soft corner protection pad. Total height reduced to a max of just 165 cm



S04445

S04449

Display LED ad alta visibilità per uso esterno appositamente sagomato per installazione all'interno della protezione curva delle panchine VIP in acciaio zincato, in moduli da cm 200 facilmente gestibile con o senza PC. Utile per la trasmissione di messaggi informativi e promozionali

High visibility LED display suitable for outdoor use, curved shape in order to be installed inside protective shell of team shelters galvanized steel, in modules of 200 cm easily operating with or without PC. Useful to provide information, promote sponsors and advertise



S04449

NOTE

Esempi di personalizzazione delle panchine della linea VIP: copertura a doppia profondità con 2 file di sedute e pedana di supporto della seconda fila (Slovenia); applicazione di pedana, con poggiatesta, mobile su ruote al modello S04442 (Sweden).

Examples of customization of VIP line's team shelters: double depth protective cover with seats in 2 lanes and supporting platform for the second lane (Slovenia); application of mobile footrest platform to model S04442 (Sweden).



SLOVENIA

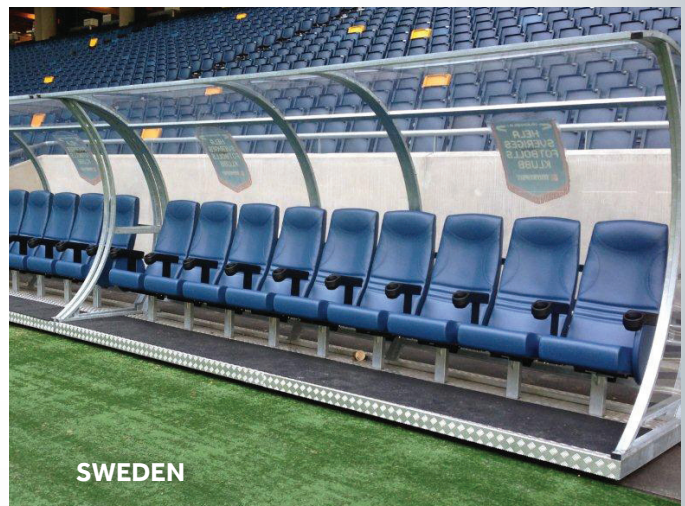

SWEDEN

NOTE

Panchine VIP per riserve ed allenatori. Stile ed eleganza a bordo campo!

Da oltre 20 anni Sport System progetta e produce una linea completa di panchine VIP per riserve ed allenatori con strutture dal design differente e realizzate in acciaio zincato, acciaio zincato e verniciato o alluminio ... fisse a terra o mobili su ruote ... con poltrone "Sport System by Lino Sonego" di differenti modelli e personalizzabili nella scelta dei colori e nel ricamo di eventuali loghi ...

Per maggiori informazioni e per richiedere un preventivo contattare info@sportssystem.it

Luxury VIP team shelters. Style and elegance on courtside!

For more than 20 years Sport System has been designing and manufacturing a complete line of VIP team shelters with different design structures made of galvanized steel, galvanized and varnished steel or aluminium ... ground fixed or portable on wheels ... equipped with armchairs "Sport System by Lino Sonego" available in different models that can be customized in different colours and by embroidering any logo ...

For more info and to obtain a quote contact info@sportssystem.it

REFERENZE

REFERENCES

Le panchine Sport System in prestigiosi stadi nazionali ed internazionali!**Sport System's luxury team shelters in prestigious international football stadiums!**

LATVIA



RUSSIA



SLOVENIA



PANAMA

REFERENZE

REFERENCES



BOSNIA AND HERZEGOVINA



ITALY



RUSSIA



MOROCCO



HUNGARY



CROATIA



MOROCCO

Accessori per arbitro

Accessories for referee

**S04452**

Taccuino da taschino per arbitro completo di cartellini
Compact referee cards set for breast pocket

**S04454**

Fischietto di acciaio con cordicella per arbitro
Metal whistle for referee with lanyard

**S04456**

Bandierina per guardalinee con manico di plastica
Linesman's flag with plastic handle

**S04458**

Drappo di ricambio di tela per bandierina guardalinee
Spare nylon flag for linesman's flag

**S04460**

Segnalatore cambio giocatori manuale bifacciale "IN" e "OUT" a 2 cifre
Manual player substitution double face board "IN" and "OUT", 2 digits

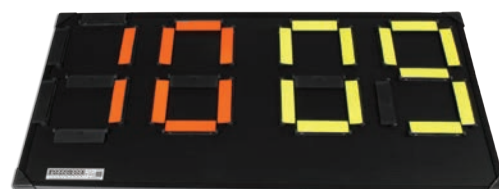
**S04462**

Segnalatore cambio giocatori manuale bifacciale "IN" e "OUT" a 2+2 cifre
Manual player substitution double face board "IN" and "OUT", 2+2 digits

S04465

Dispositivo elettronico di segnalazione cambio giocatori monofacciale bicolore a 2+2 display
Electronic substitute indicator with 4 digits (2+2 of different colours), single face

**S04469**

Valigetta per dispositivi S04465 e S04467
Carrying case for indicators S04465 and S04467

**S04467**

Dispositivo elettronico di segnalazione cambio giocatori bifacciale bicolore a 2+2 display
Electronic substitute indicator with 4 digits (2+2 of different colours), 2 faces

**S04471**

Dispositivo elettronico S04467 completo di pannello sponsor superiore
Electronic substitute indicator S04467 with sponsor's space on top

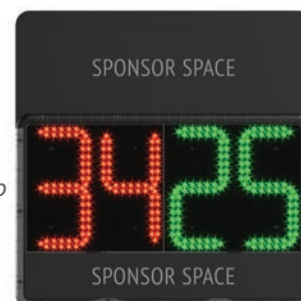

Video dimostrativo disponibile al sito www.sportssystem.it nella sezione filmati.

Demonstrative video available at www.sportssystem.it in movies section.

**S04473**

Valigetta per dispositivo S04471
Carrying case for indicator S04471



S04502

S04502

Arco regolabile in plastica flessibile per tiri di precisione

Adjustable shape mini goal bow made of flexible plastic



S04504

S04504

Coppia porte mini-calcio in plastica flessibile con reti, cm 150x110

Pair of flexible plastic mini-soccer goals with nets, 150x110 cm

S04506

Coppia porte mini-calcio in acciaio con reti, cm 150x110 (come S05132)

Pair of varnished steel mini-soccer goals with nets, 150x110 cm (as S05132)



S04507

S04507

Coppia porte mini-calcio professionali in acciaio con reti, cm 150x110, diametro mm 80

Pair of professional varnished steel mini-soccer goals with nets, 150x110 cm, diameter 80 mm

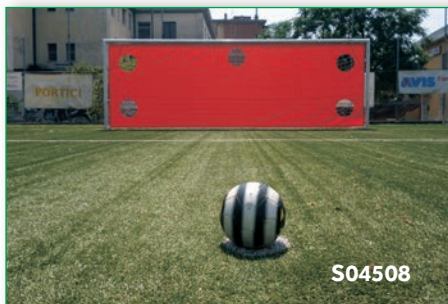

S04508

S04508

Telo di PVC per tiri di precisione da fissare alla porta calcio standard con dimensioni cm 732x244

PVC banner for precision shot training to be fixed to standard soccer goals with dimensions 732x244 cm

S04510

Telo di PVC per tiri di precisione da fissare alla porta calcio ridotto con dimensioni cm 600x200

PVC banner for precision shot training to be fixed to reduced soccer goals with dimensions 600x200 cm

S04512

Telo di PVC per tiri di precisione da fissare alla porta calcetto standard con dimensioni cm 300x200

PVC banner for precision shot training to be fixed to standard futsal goals with dimensions 300x200 cm



S04516

S04516

Ostacolo per allenamento di acciaio, graduabile in altezza a cm 60, 70, 80, 90

Training steel hurdle ajustable in height 60, 70, 80, 90 cm

**S04518**

Set nr 6 ostacoli OVER in PVC con altezze cm 12, 20, 30, 40, 50, 60

Set of nr 6 OVER hurdles in PVC with heights 12, 20, 30, 40, 50, 60 cm



S04514

S04514

Ostacolo per allenamento di acciaio, graduabile in altezza a cm 30, 40, 50

Training steel hurdle ajustable in height 30, 40, 50 cm



S04520

S04520

Ostacolo in PVC richiudibile con meccanismo a molla, altezze regolabili da cm 10 a cm 60

PVC spring reclining hurdle adjustable in height from 10 cm to 60 cm

**S04522**

Ostacolo per allenamento di plastica graduabile in altezza da cm 50 a cm 100
Training plastic hurdle adjustable in height from 50 cm up to 100 cm

**S04528**

Mini cono calpestabile in PVC morbido, altezza cm 15
Mini cone made of super soft PVC, height 15 cm

**S04534**

Paletto slalom di plastica con puntale in acciaio
Slalom pole made of plastic with metal peak



S04524

S04526

S04524

Set di 24 delimitatori in plastica colorata con supporto
Set of 24 small cones made of coloured plastic with support

S04526

Set di 48 delimitatori in plastica colorata con supporto
Set of 48 small cones made of coloured plastic with support



S04530

**S04530**

Set di 48 delimitatori in plastica colorata con supporto, foro superiore sagomato per sostegno aste
Set of 48 small cones made of coloured plastic with support, upper hole shaped for supporting poles

**S04532**

Griglia in plastica e tessuto per esercizi di coordinazione
Plastic and fabric training grill for coordination exercises



S04536

S04536

Paletto slalom con base per uso indoor o per campi in sintetico
Slalom pole with base for indoor use or use on artificial grass court

**S04540**

Forca per allenamento gioco testa, palloni esclusi
Header practice stand, balls not included

**S04542**

Forca per allenamento gioco testa con base zavorrabile mobile su ruote, pallone escluso

Portable header practice stand, base to be filled equipped with wheels, ball not included

**S04544**

Sagoma gonfiabile per allenamento, altezza cm 200, con base autoportante, soffice e sicura

Inflatable dummy for training, height 200 cm, self-standing base, soft and safe

**S04548****S04548**

Sagoma snodata in gomma soffice per allenamento, con puntali per fissaggio a terra, altezza regolabile

Flexible penalty dummy made of soft rubber, with ground steel peaks, height adjustable

**S04550****S04550**

Carrello mobile di acciaio verniciato per supporto di nr 5 sagome S04548 (sagome escluse)

Varnished steel trolley supporting 5 dummies S04548 (dummies not included)

**S04552****S04552**

Carrello singolo per supporto e spostamento sagoma S04548 su sintetico (sagoma esclusa)

Single trolley supporting and sliding dummy S04548 on artificial grass (dummy not included)

**S04552 - ZOOM**



S04554

S04554

Paracadute con cintura per esercizi di potenziamento della corsa
Parachute with bell useful to improve run's power



S04556

S04556

Slitta con cintura in pelle, corda e moschettoni per esercizi di potenziamento della corsa e dell'accelerazione (pesi esclusi)
Sledge with leather bell, rope and hooks useful to improve run's power and player's acceleration performance (weights not included)

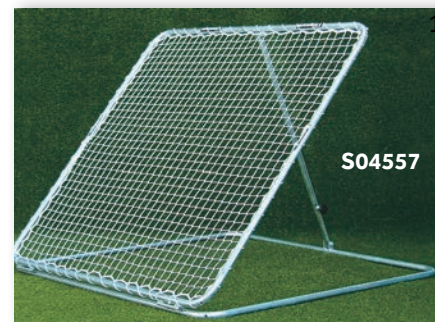

S04557

S04557

Telaio con rete funzionale ad allenamento portieri e giocatori, in acciaio zincato ad inclinazione regolabile, dimensioni cm 140x140
Inclined frame with net for training goal-keepers and players, galvanized steel, dimensions 140x140 cm

**S04558**

Macchina spara-palloni Globus Eurogoal 1500 funzionale ad un allenamento completo per il calcio, in grado di effettuare tiri in porta per allenamento dei portieri, cross ed assist per allenamento degli attaccanti; regolazione della velocità di uscita della palla fino a 140 km/h; regolazione della traiettoria del tiro e degli effetti imprimibili al pallone; funzionamento a batteria ricaricabile
Globus Eurogoal 1500 balls shooting machine for soccer functional to a complete training session permitting to serve goal shots to goal keeper, crosses and assist with extreme realism to striker; ball's speed adjustment up to 140 km/h; possibility to adjust ball's trajectories as well as ball's spin; working with rechargeable battery



Video dimostrativo disponibile al sito www.sportssystem.it nella sezione filmati.

Demonstrative video available at www.sportssystem.it in movies section.



S04560

S04560

Casacca fluorescente colorata per allenamento
Fluorescent training coloured bib

**S04562**

Lavagna magnetica per calcio con pedine, dimensioni cm 85x60
Magnetic tactic charts for soccer, dimensions 85x60 cm

Carrelli segna campo, bandierine calcio angolo, accessori campi calcio
Pitch marker trolleys, corner flags, accessories for soccer field



S04570

S04570

Carrello segna campo a polvere in acciaio zincato
Galvanized steel pitch marker trolley using powder



S04571

S04571

Carrello segna campo a vernice ecologica con funzionamento a rulli
Pitch marker trolley using ecological paint operating by rollers



S04572

S04572

Carrello segna campo a vernice ecologica con pompa manuale
Pitch marker trolley using ecological paint with manual pressure pump



S04574

S04574

Carrello segnacampo a vernice ecologica con pompa elettrica a batteria
Pitch marker trolley using ecological paint with electric pump operating with battery



S04575

S04575

Carrello segnacampo a vernice ecologica con pompa a caricamento automatico di pressione
Pitch marker trolley using ecological paint with automatic pressure pump



S04576

S04576

Carrello segna campo a vernice ecologica con motore a scoppio
Pitch marker trolley using ecological paint operating by cusion engine

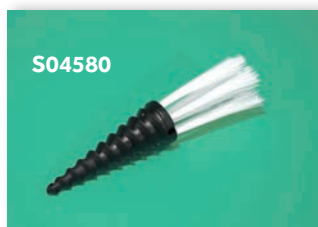

S04580

S04580
Plifix accessorio per la
tracciatura del campo
Plifix suitable for line marking

S04578
Vernice ecologica per carrello
segna campo in fusto da 14 lt
*Barrel with 14 lt of ecological
paint*



S04584



S04582

S04582
Griglia per pulizia scarpe in acciaio zincato, autoportante
Galvanized steel self-standing grill for shoes cleaning

S04584
Totem lava scarpe con struttura in acciaio verniciato
completa di poggia-mani, sistema di pulizia suola e tomaia
con 2+2 spazzole a setole di nylon e sistema di spruzzo in
acciaio zincato con 4 getti; comprese bandelle per fissaggio a
terra e raccordo per tubatura
*Shoes washing totem with handled varnished steel structure,
cleaning system for shoes' upper and lower sides composed of
2+2 nylon brushes and 4 water spray nozzles; including ground
fixing frame and connection to water pipe*



S04586

S04586
Bandierina calcio d'angolo con palo fisso antinfortunistico
di plastica bianca, diametro mm 30, drappo in poliestere di
colore giallo cm 60x40, bussola con tappo e clip
*White plastic fixed corner pole, diameter 30 mm, yellow
polyester flag 60x40 cm, socket with cap and clip*



S04588

S04588
Bandierina calcio d'angolo con palo snodato antinfortunistico
di plastica bianca, diametro mm 30, drappo in poliestere di
colore giallo cm 60x40, bussola con tappo e clip
*White plastic flexible corner pole, diameter 30 mm, yellow
polyester flag 60x40 cm, socket with cap and clip*



S04590

S04590
Drappo di ricambio in poliestere per bandierine calcio angolo, dimensioni cm 45x45,
disponibile nei colori giallo, arancio e scacchi giallo/arancio
*Spare polyester flag for corner pole 45x45 cm, available in yellow, orange and
checkered yellow/orange colors*

**S04592**

Tunnel estensibile di protezione dell'accesso dei giocatori sul campo di gioco (indoor o outdoor), struttura in alluminio con movimento a pantografo su ruote, telo di PVC colorato
Extendable tunnel protecting players' entry on sport court (indoor or outdoor), aluminum structure scissor-style working, mobile on wheels, colored PVC cover



S04592

NOTE

Tunnel estensibile S04592 personalizzabile nelle dimensioni, dal punto di vista funzionale ed estetico, a richiesta.

Extendable tunnel S04592 can be customized on dimensions, under the functional and aesthetic points of view, on demand.



S04592



S04595

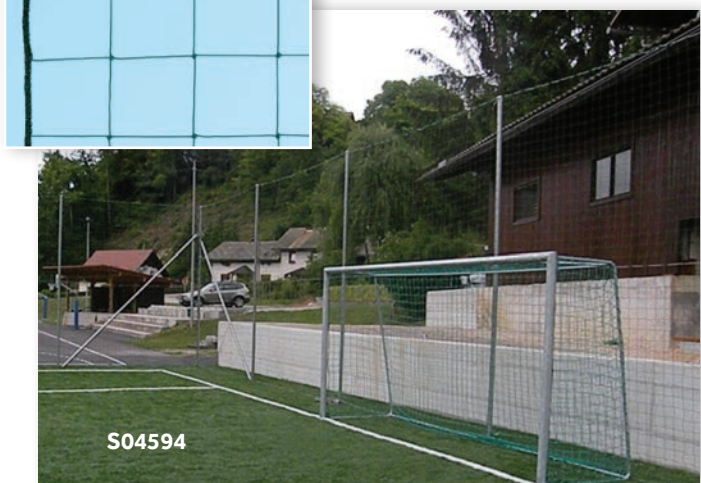

S04594

S04594

Rete di protezione fondocampo in polietilene verde, diametro mm 3, maglia cm 13x13, lavorazione con nodo
Protective boundary net made of green polyethylene, diameter 3 mm, mesh 13x13 cm, knotted

S04595

Bordatura perimetrale per rete di protezione fondocampo S04594

Bording cord for protective boundary net S04594



S04596

S04596

Veicolo ambulanza per campi calcio con supporto per barella e seduta per assistente medico, motore elettrico con funzionamento a batteria, fornito completo di carica batterie e barella pieghevole in alluminio

Ambulance vehicle for transferring injured players on soccer field, with stretcher support and seat for doctor, electric engine working with rechargeable battery, supplied with battery charger and foldable stretcher in aluminium



S04602

S04602 ✓ EN16579 tested

Coppia porte calcetto in alluminio verniciato sezione mm 80, dimensioni cm 300x200, modello mobile con base
Pair of aluminium futsal goals round section 80 mm, dimensions 300x200 cm, portable model with ground base

S04603 ✓ EN16579 tested

Coppia porte calcetto in alluminio verniciato sezione mm 80, dimensioni cm 300x200, modello a bussole
Pair of aluminium futsal goals round section 80 mm, dimensions 300x200 cm, ground sockets model



S04603 - ZOOM

S04604

Coppia porte calcetto in alluminio verniciato sezione mm 80, dimensioni cm 300x200, modello mobile con base e reggirete reclinabile
Pair of aluminium futsal goals round section 80 mm, dimensions 300x200 cm, portable model with ground base and hinged net supports



S04605



S04605

S04605 **NEW** ✓ EN749 tested

Coppia porte calcetto in alluminio verniciato sezione mm 80, dimensioni cm 300x200, modello con zavorre incluse
Pair of varnished aluminium futsal goals round section 80 mm, dimensions 300x200 cm, model with weights included



S04606 - S04608

S04606 ✓ EN749 tested

Coppia porte calcetto in acciaio verniciato sezione mm 80, dimensioni cm 300x200, modello mobile con base e pali saldati alla traversa
Pair of varnished steel futsal goals round section 80 mm, dimensions 300x200 cm, portable model with ground base and posts welded to crossbar



S04607

S04607 ✓ EN749 tested

Coppia porte calcetto in acciaio zincato sezione mm 80, dimensioni cm 300x200, modello mobile con base e pali saldati alla traversa
Pair of galvanized steel futsal goals round section 80 mm, dimensions 300x200 cm, portable model with ground base and posts welded to crossbar

S04608

✓ EN749 tested

Coppia porte calcetto in acciaio verniciato sezione mm 80, dimensioni cm 300x200, modello smontabile, mobile con base

Pair of varnished steel futsal goals round section 80 mm, dimensions 300x200 cm, portable mode with ground base, completely dismantled

S04609

Set 4 bussole con innesti adattabili a tutti i modelli di porte in acciaio per calcetto (S04606, S04607, S04608) e per calcio ridotto (S04314, S04320, S04326)

Set 4 sockets with connections to be installed on all steel goals for futsal (S04606, S04607, S04608) and for reduced soccer (S04314, S04320, S04326)

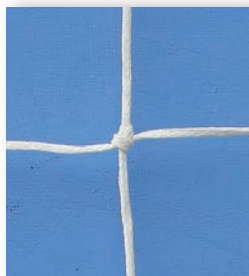
**S04610**

Coppia reti calcetto cm 300x200 in polietilene diametro mm 2,5 con nodo, profondità cm 100/100, maglia quadra cm 10x10

Pair of nets for futsal goals 300x200 cm made of polyethylene diameter 2.5 mm knotted, depth 100/100 cm, square mesh 10x10 cm

**S04612**

Coppia reti calcetto cm 300x200 in nylon diametro mm 5 con nodo, profondità cm 100/100, maglia quadra cm 10x10

Pair of nets for futsal goals 300x200 cm made of nylon diameter 5 mm knotted, depth 100/100 cm, square mesh 10x10 cm

**S04614****S04614**

Ventosa con clip per fissaggio a terra porte calcetto

Suction cap with hook for goal ground fixation

**S04615****S04615**

Sacco zavorra da kg 20 in PVC elettrosaldato con maniglia

Ballast bag 20 kg made in electro-welded PVC with handle

**S04616****S04616**

NEW

Modulo zavorra in acciaio zincato per porte calcetto, calcio ridotto e pallamano in acciaio

Galvanized steel ballast module for futsal, reduced football and handball goals in steel

15

Pallamano - Handball

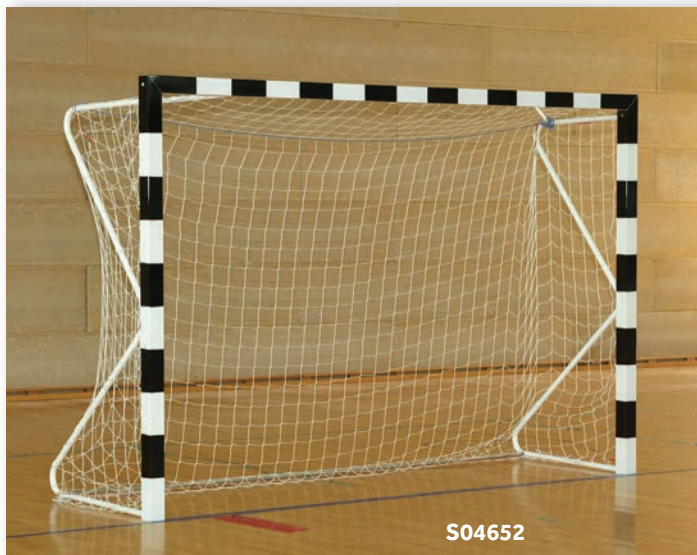
**S04652****S04652**

✓ EN749 tested

Coppia porte pallamano in alluminio verniciato sezione mm 80x80, dimensioni cm 300x200, modello mobile con base

Pair of varnished aluminium handball goals section 80x80 mm, dimensions 300x200 cm, portable model with ground base

S04653

✓ EN749 tested

Coppia porte pallamano in alluminio verniciato sezione mm 80x80, dimensioni cm 300x200, modello a bussole

Pair of varnished aluminium handball goals section 80x80 mm, dimensions 300x200 cm, ground sockets model



S04654

S04654 ✓ EN749 tested

Coppia porte pallamano in alluminio verniciato sezione mm 80x80, dimensioni cm 300x200, modello mobile con base e reggirete reclinabili

Pair of varnished aluminium handball goals section 80x80 mm, dimensions 300x200 cm, portable model with ground base and hinged net supports



S04660

S04660

Coppia porte pallamano in legno verniciato sezione mm 80x80, dimensioni cm 300x200, modello mobile con base

Pair of varnished wooden handball goals section 80x80 mm, dimensions 300x200 cm, portable model with ground base

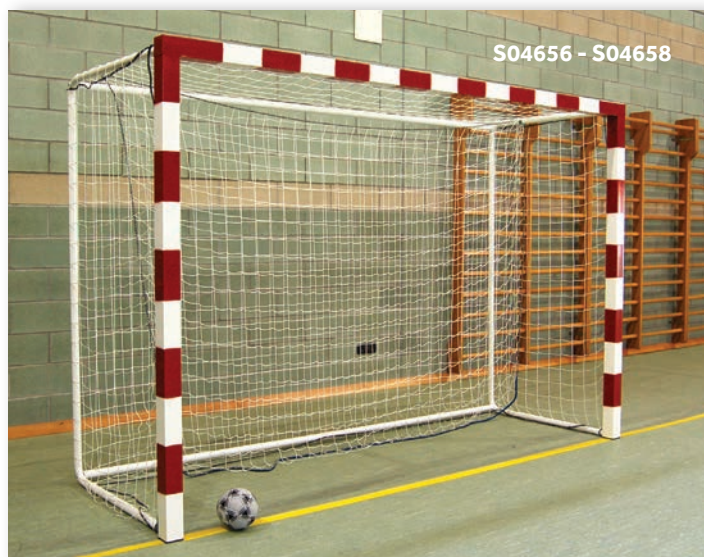

S04656 - S04658

S04656 ✓ EN749 tested

Coppia porte pallamano in acciaio verniciato sezione mm 80x80, dimensioni cm 300x200, modello mobile con base e pali saldati alla traversa

Pair of varnished steel handball goals section 80x80 mm, dimensions 300x200 cm, portable model with ground base and posts welded to crossbar

S04658 ✓ EN749 tested

Coppia porte pallamano in acciaio verniciato sezione mm 80x80, dimensioni cm 300x200, modello smontabile, mobile con base

Pair of varnished steel handball goals section 80x80 mm, dimensions 300x200 cm, portable model with ground base, completely dismantled

**S04662**

Coppia reti pallamano cm 300x200 in nylon diametro mm 3 senza nodo, profondità cm 100/100, maglia quadra cm 10x10

Pair of nets for handball goals 300x200 cm made of nylon diameter 3 mm knotless, depth 100/100 cm, square mesh 10x10 cm

S04663

Coppia reti pallamano cm 300x200 in nylon diametro mm 6 senza nodo, profondità cm 100/100, maglia quadra cm 10x10

Pair of nets for handball goals 300x200 cm made of nylon diameter 6 mm knotless, depth 100/100 cm, square mesh 10x10 cm



S04665 rete ammortizzatrice / absorbing net - ZOOM

S04665

Coppia appendici in nylon diametro mm 3 con corda piombata aventi funzione di ammortizzatrici per reti S04662 e S04663

Pair of additional catch nets made of nylon 3 mm with leaded rope, to be used with nets S04662 and S04663



S04668

S04668

Coppia staffe in acciaio zincato con ruota gommata per movimentazione porte pallamano

Pair of galvanized steel supports with rubber wheel to be used for moving handball goals



S04670

S04670

Coppia porte pallamano in alluminio, omologate IHF, reggirete reclinabili, dimensioni regolamentari cm 300x200, complete di accessori di fissaggio a terra

Pair of light aluminium handball goals, IHF approved, hinged net supports, standard dimensions 300x200 cm, ground fixing accessories included



S04672

S04672

Carrello in acciaio verniciato per stoccaggio e movimentazione porte pallamano con reggirete reclinabili (S04654, S04670)

Varnished steel trolley for storing and rolling away handball goals with hinged net supports (S04654, S04670)

15

Impianti pallavolo e protezioni Volley posts and protective pads



S04704

S04704

Impianto pallavolo in acciaio verniciato da fissare a parete, con dispositivo tendirete

Wall mounted volleyball system made of varnished steel, with net tensioner



S04706

S04706

Coppia protezioni imbottite per impianti pallavolo S04702 e S04704

Pair of protective pads for volleyball systems S04702 and S04704

NOTE

Tutte le protezioni sono realizzate in gomma espansa sagomata e sono interamente rivestite in PVC (anche nell'area interna a contatto con il palo da proteggere).

All protective pads are made with interior in soft foam and are entirely covered in PVC (even the inside area in contact with post to be protected).



S04708

S04708

Impianto pallavolo a traliccio in acciaio verniciato mobile su ruote, con dispositivo tendirete, modello scolastico

Freestanding portable volleyball system mobile on wheels, made of varnished steel with net tensioner, school model

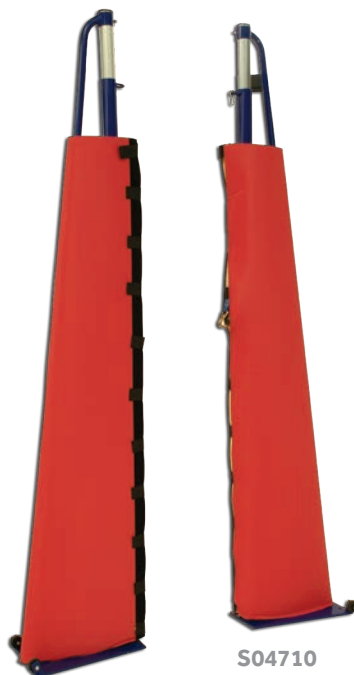

S04710

S04710

Coppia protezioni imbottite per impianto pallavolo S04708

Pair of protective pads for volleyball system S04708



S04712

S04712

Impianto pallavolo a traliccio in acciaio verniciato mobile su ruote, con dispositivo tendirete, modello rinforzato

Freestanding portable volleyball system mobile on wheels, made of varnished steel with net tensioner, reinforced model



S04714

S04714

Coppia protezioni imbottite per impianto pallavolo S04712

Pair of protective pads for volleyball system S04712



S04716

S04716

Impianto pallavolo a traliccio in alluminio verniciato mobile su ruote, con dispositivo tendirete

Freestanding portable volleyball system mobile on wheels, made of varnished aluminium with net tensioner



S04717

S04717

Impianto pallavolo a traliccio in alluminio S04716 dotato di ruote maggiorate e cassetta porta zavorra

Freestanding portable volleyball system S04716 equipped with larger wheels and box to be filled with ballast



S04718

S04718

Serie protezioni imbottite per impianti pallavolo S04716 e S04717

Set of protective pads for volleyball system S04716 and S04717

S04721

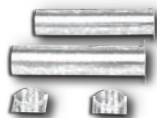
**S04721**

Impianto pallavolo monotubolare in acciaio zincato a caldo, suggerito per uso esterno, con bussole e dispositivo tendirete

Hot-dip galvanized steel volleyball system, suggested for outdoor use, with ground sockets and net tensioner

S04722

**S04722**

Impianto pallavolo monotubolare in acciaio zincato con bussole e dispositivo tendirete

Galvanized steel volleyball system with ground sockets and net tensioner



S04724

S04724

Coppia protezioni imbottite per impianti pallavolo S04721 e S04722

Pair of protective pads for volleyball systems S04721 and S04722



S04726

S04726

Impianto pallavolo monotubolare in acciaio verniciato con bussole e dispositivo tendirete, regolazione telescopica dell'altezza, protezioni comprese, a norme FIVB

Varnished steel volleyball system with ground sockets and net tensioner, telescopic height adjustment, including pads. in accordance to FIVB rules

S04728

**S04728**

Impianto pallavolo monotubolare in alluminio verniciato con bussole e dispositivo tendirete, omologato FIVB per competizioni internazionali

Varnished aluminium volleyball system with ground sockets and net tensioner, FIVB approved for international competitions

S04730

**S04730**

✓ FIVB approved

Coppia protezioni imbottite per impianto pallavolo omologato FIVB
Pair of protective pads for volleyball system FIVB approved

S04732

**S04732**

✓ EN1271 tested

Impianto pallavolo monotubolare in alluminio verniciato, sezione ovale, con bussole e dispositivo tendirete
Varnished aluminium oval section volleyball system with ground sockets and net tensioner

S04733

**S04733**

✓ EN1271 tested

Impianto pallavolo monotubolare in alluminio verniciato, sezione ovale, con bussole e dispositivo tendirete, modello telescopico
Varnished aluminium oval section volleyball system with ground sockets and net tensioner, telescopic model

S04734

**S04734**

Coppia protezioni imbottite per impianti pallavolo S04732 e S04733
Pair of protective pads for volleyball systems S04732 and S04733

S04736

**S04736**

✓ EN1271 tested

Impianto pallavolo monotubolare in alluminio a sezione rotonda mm 100 secondo norma DIN 7896 con bussole, dispositivo tendirete e protezioni imbottite
Varnished aluminium round section 100 mm volleyball system with ground sockets, net tensioner and protective pads, in accordance to DIN 7896

S04738

Dispositivo tendirete di ricambio per impianti pallavolo in acciaio S04704, S04708, S04712, S04721 e S04722
Net tensioner device for steel volleyball systems S04704, S04708, S04712, S04721 and S04722

S04740

**S04740**

Dispositivo tendirete di ricambio per impianti pallavolo in alluminio S04716, S04717, S04732 e S04733
Net tensioner device for aluminium volleyball systems S04716, S04717, S04732 and S04733

16

Reti e accessori Nets and accessories

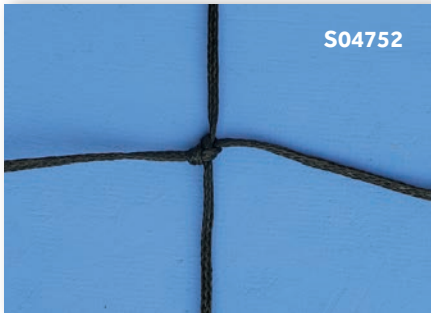

S04752

S04752

Rete pallavolo regolamentare in polietilene diametro mm 2,5 con nodo, completa di cavo in acciaio e nastro in PVC

Standard volleyball net made of polyethylene diameter 2.5 mm knotted, complete of cable and PVC ribbon

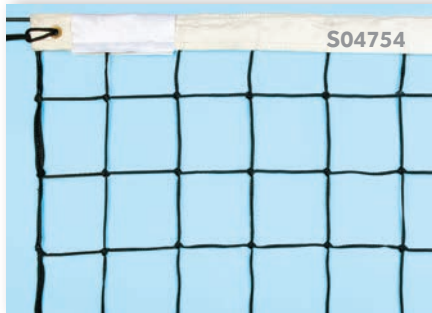

S04754

S04754

Rete pallavolo Torneo in polietilene diametro mm 3 con nodo, completa di nastro, cavo e bande mobili con antenne

Torneo model net for volleyball made of polyethylene diameter 3 mm knotted, with upper ribbon, antennas' sleeves and antennas

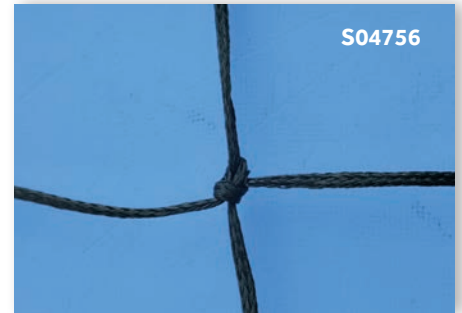

S04756

S04756

Rete pallavolo da competizione in polietilene diametro mm 3,5 con nodo, completa di nastri in PVC superiore da mm 70 e inferiore da mm 50, tasche porta antenne ed antenne

Competition volleyball net made of polyethylene diameter 3.5 mm knotted, complete of PVC ribbons 70 mm on top and 50 mm on bottom, antennas' sleeves and antennas

S04757

Rete pallavolo da competizione in polietilene diametro 3,5 mm con nodo, completa di nastri in PVC superiore da mm 70 e inferiore da mm 50, tasche porta antenne ed antenne. Maglia mm 45x45

Competition volleyball net made of polyethylene diameter 3.5 mm knotted, complete of PVC ribbons 70 mm on top and 50 mm on bottom, antennas' sleeves and antennas. Mesh 45x45 mm



S04758 FIVB approved

Rete pallavolo completa di antenne, omologata FIVB per competizioni
Volleyball net with antennas, FIVB approved for competition



S04760

S04760

Coppia bande mobili con tasche porta antenne

Pair of antennas' sleeves for volleyball net

NOTE

Sport System offre la possibilità di personalizzare i nastri delle reti S04756 e S04757 con la stampa di loghi e testi.

Sport System offers possibility to customize, with text or logos, the two ribbons of nets S04756 and S04757.

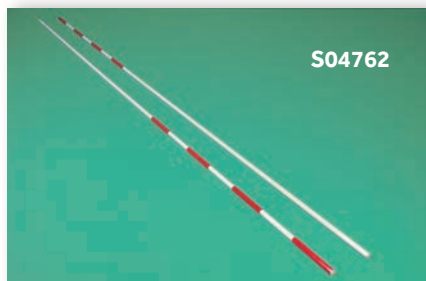
**S04762**

Coppia antenne di vetroresina in unico elemento

Pair of single piece fibreglass antennas for volleyball net

**S04764**

Coppia antenne di vetroresina componibili in 2 elementi

Pair of two pieces fibreglass antennas for volleyball net

**S04765**

 FIVB approved

Coppia antenne omologate FIVB per competizioni

Pair of two pieces antennas FIVB approved for competition

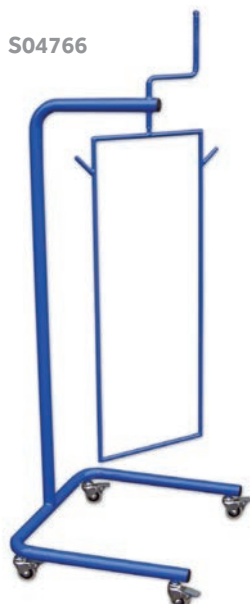
**S04766**

Avvolgitore per rete pallavolo in acciaio verniciato

Varnished steel support for rolling up volleyball net

S04768**NEW**

Misuratore di plastica per verifica altezza rete pallavolo

Plastic height measurer device for volleyball net

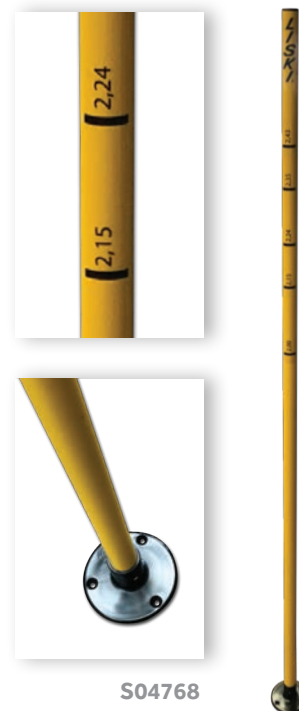
**S04770**

Carrello per trasporto impianti pallavolo, reti ed accessori con struttura in acciaio verniciato, mobile su ruote

Varnished steel trolley for volleyball posts, nets and accessories, mobile on wheels



Inquadra il QR Code di sinistra col tuo cellulare per accedere alla sezione Giochi del sito www.sportssystem.it

Scan the QR Code at your right with your mobile phone to navigate the Games section at www.sportssystem.it site

**LINK**



S04802

S04802

Palchetto per arbitro pallavolo ad altezza fissa, in acciaio verniciato, mobile su ruote

Volleyball referee platform made of varnished steel, mobile on wheels



S04804

S04804

Palchetto per arbitro pallavolo ad altezza fissa con scocca di seduta, in acciaio verniciato, mobile su ruote

Volleyball referee platform with plastic seat, made of varnished steel, mobile on wheels



S04805

S04805

Protezione imbottita e sagomata per palchetti S04802 e S04804, fissaggio con Velcro

Soft protective pad shaped for referee platforms S04802 and S04804, closure by Velcro



S04806

S04806

Palchetto professionale per arbitro pallavolo regolabile in altezza con scocca di seduta, in acciaio verniciato, mobile su ruote

Professional volleyball referee platform with adjustable height, plastic seat, made of varnished steel, mobile on wheels

S04808

**S04808**

Protezione imbottita e sagomata per palchetto S04806, fissaggio con Velcro

Soft protective pad shaped for referee platform S04806, closure by Velcro



S04809

S04809

Protezione imbottita e sagomata per palchetto S04806, fissaggio con Velcro - modello da gara

Soft protective pad shaped for referee platform S04806, closure by Velcro - competition model



S04810

S04810

Palchetto per arbitro pallavolo, omologato FIVB per competizioni, completo di imbottiture

Volleyball referee platform, FIVB approved for competitions, included protective pads

S04812

**S04812**

Segnapunti manuale da tavolo per pallavolo

Portable desk manual scoreboard for volleyball



S04814

S04814

Segnapunti manuale a 4 cifre (2+2) su struttura girevole con base in acciaio verniciato

Manual scoreboard with 4 digits (2+2) on revolving varnished steel structure with base

**S04815**

Segnalatore acustico e luminoso portatile per time-out

Portable time-out acoustic buzzer and light signaller

**S04816**

Serie palette numerate in legno per sostituzione giocatori (1-18)

Set of numbered wooden boards for player substitution (1-18)

S04817

**S04817**

Serie palette numerate in legno per sostituzione giocatori (1-20)

Set of numbered wooden boards for player substitution (1-20)

S04818

Set cambio giocatori e time-out composto di serie palette numerate su contenitore in legno, struttura mobile in acciaio verniciato, dispositivo acustico e luminoso (1-18)

Player substitution and time-out kit including set of numbered plastic boards on wooden case, varnished steel structure mobile on wheels, acoustic and luminous signals (1-18)

S04819

Set cambio giocatori e time-out composto di serie palette numerate su contenitore in legno, struttura mobile in acciaio verniciato, dispositivo acustico e luminoso (1-20)

Player substitution and time-out kit including set of numbered plastic boards on wooden case, varnished steel structure mobile on wheels, acoustic and luminous signals (1-20)



S04818 - S04819

S04820

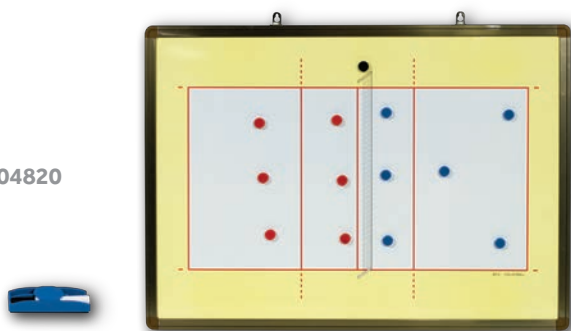
**S04820**

Lavagna magnetica per pallavolo con pedine, dimensioni cm 85x60
Magnetic tactic charts for volleyball, dimensions 85x60 cm

**S04822**

Misuratore di elevazione con struttura in acciaio, mobile su ruote, base zavorrata
Jump performances measurer on mobile varnished steel structure, heavy base

**S04824**

Volleyball Training per allenamento ai tiri di precisione, struttura di acciaio mobile su ruote, base zavorrata
Volleyball Training equipment suitable for precision training, mobile on wheels, heavy base

**S04826**

Volleyball Player per allenamento al servizio, alla schiacciata ed al muro difensivo, struttura di acciaio mobile su ruote, base zavorrata
Volleyball Player equipment suitable for training on service, smash and defensive wall, heavy base

**S04830**

Macchina spara-palloni Globus Winshot 1500 funzionale ad un allenamento completo per il volley, in grado di simulare servizi, alzate e schiacciate; regolazione della velocità di uscita della palla fino a 140 km/h; regolazione della traiettoria del tiro e degli effetti imprimibili al pallone; funzionamento a batteria ricaricabile

Globus Winshot 1500 balls shooting machine for volley, functional to a complete training session permitting to services and attacks; ball's speed adjustment up to 140 km/h; possibility to adjust ball's trajectories as well as ball's spin; working with rechargeable battery

18

Pali minivolley e reti Minivolley posts and nets

S04842

**S04842**

Coppia pali minivolley in acciaio verniciato con basi zavorrabili, mobili su ruote, facilmente smontabili

Pair of freestanding minivolley posts made of varnished steel, bases to be filled, mobile on wheels, demountable

**S04844**

Rete super minivolley in polietilene diametro mm 3, dimensioni cm 650x100, maglia quadra cm 10x10

Super minivolley net made of polyethylene diameter 3 mm, dimensions 650x100 cm, square mesh 10x10 cm

S04846

Rete minivolley in polietilene diametro mm 3, dimensioni cm 550x100, maglia quadra cm 10x10

Minivolley net made of polyethylene diameter 3 mm, dimensions 550x100 cm, square mesh 10x10 cm

Tennis e Padel - pali e reti

Tennis and Padel - posts and nets



S04852

S04852

Coppia pali tennis per palestra in acciaio verniciato a sezione quadrata con dispositivo tendirete

Pair of tennis posts for gym made of square section varnished steel with net tensioner



S04854

S04854

✓ EN1510 tested

Coppia pali tennis per palestra in alluminio verniciato a sezione ovale con dispositivo tendirete

Pair of tennis posts for gym made of oval section varnished aluminium with net tensioner

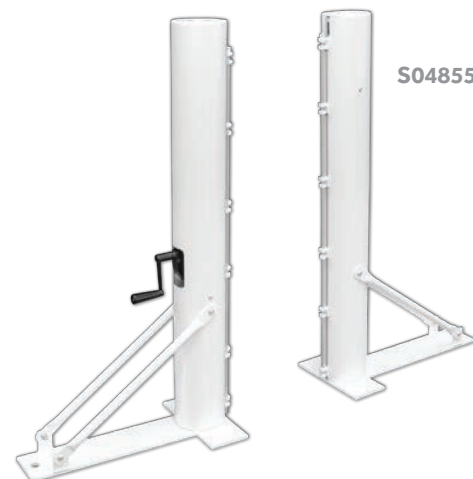

S04855

S04855

NEW

Coppia pali padel in alluminio a sezione ovale con piastra di fissaggio a terra e dispositivo tendirete

Pair of padel posts made of oval section varnished aluminium with ground plate and net tensioner



S04856

S04856

✓ EN1510 tested

Coppia pali tennis monotubolari in acciaio verniciato a sezione quadrata con dispositivo tendirete e bussole

Pair of tennis posts made of square section varnished steel with ground sockets and net tensioner



S04858

S04858

✓ EN1510 tested

Coppia pali tennis monotubolari in acciaio zincato a sezione quadrata con dispositivo tendirete e bussole

Pair of tennis posts made of square section galvanized steel with ground sockets and net tensioner



S04860

S04860

✓ EN1510 tested

Coppia pali tennis monotubolari in alluminio verniciato a sezione ovale con dispositivo tendirete e bussole

Pair of tennis posts made of oval section varnished aluminium with ground sockets and net tensioner

S04861

**S04861**

Coppia pali padel monotubolari in alluminio verniciato a sezione ovale con dispositivo tendirete e bussole

Pair of padel posts made of oval section varnished aluminium with ground sockets and net tensioner

S04866

**S04866**

Dispositivo tendirete di ricambio per pali tennis e padel in alluminio S04854, S04855, S04860 e S04861

Net tensioner device for aluminium tennis and padel posts S04854, S04855, S04860 and S04861



S04862

S04862

Impianto tennis in acciaio zincato ad elementi componibili, trasportabile su ruote, completo di pedane porta zavorra (zavorra esclusa)

Freestanding tennis system made of several elements in galvanized steel, mobile on wheels, complete of ballast's supports (ballast not included)

S04868

Coppia paletti in acciaio zincato per sostegno rete gioco tennis singolo

Pair of galvanized steel net posts for single match



S04868

**S04864**

Dispositivo tendirete di ricambio per pali tennis in acciaio S04852, S04856 e S04858

Net tensioner device for steel tennis posts S04852, S04856 and S04858

S04870

Rete tennis regolamentare in polietilene diametro mm 2,5 con nodo, nastro in pvc, maglia quadra cm 4,5x4,5

Standard tennis net made of polyethylene diameter 2.5 mm knotted, complete of pvc ribbon, square mesh 4.5x4.5 cm

**S04872**

Rete tennis professionale in polipropilene diametro mm 4 senza nodo, 6 maglie doppie di rinforzo superiore, nastro in cotone, maglia esagonale

Professional tennis net made of polypropylene diameter 4 mm knotless, 6 double reinforcing mesh on upper part, complete of cotton ribbon, hexagonal mesh

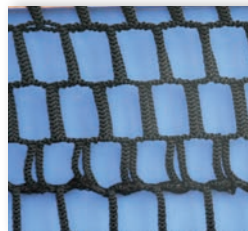

S04873

Rete padel professionale in polipropilene diametro mm 4 senza nodo, 6 maglie doppie di rinforzo superiore, nastro in cotone, maglia esagonale

Professional padel net made of polypropylene diameter 4 mm knotless, 6 double reinforcing mesh on upper part, complete of cotton ribbon, hexagonal mesh

S04874

Nastro in poliestere per fascia superiore rete tennis

Polyester replacing net band



S04876

S04876

Centro rete tennis in poliestere con gancio e fibbia

Polyester center strap for tennis net

20

Sedia per arbitro, panchine e articoli vari campo tennis
Referee platforms, benches and other equipment for tennis court



S04902

S04902

Sedia in acciaio verniciato per arbitro tennis, completa di scocca di seduta e leggio ribaltabile, mobile su ruote

Tennis referee platform made of varnished steel, mobile on wheels, with plastic seat and tip-up writing board



S04904

S04904

Sedia in acciaio zincato per arbitro tennis, completa di scocca di seduta e leggio ribaltabile, mobile su ruote

Tennis referee platform made of galvanized steel, mobile on wheels, with plastic seat and tip-up writing board

S04905

**S04905**

Sedia in alluminio per arbitro tennis, completa di scocca di seduta chiudibile e leggio ribaltabile

Tennis referee platform made of aluminium, complete of plastic tip-up chair and tip-up writing board



S04906

S04906

Panchina bordo campo tennis, struttura in acciaio zincato lunghezza cm 200, seduta e schienale a doghe di legno trattato per esterno

Bench for tennis court, galvanized steel structure length 200 cm, backrest and seating area made of wooden panels refined for outdoor use



S04910

S04910

Panchina bordo campo tennis, struttura in acciaio zincato lunghezza cm 200 con nr 4 scocche di seduta in polipropilene colorato

Bench for tennis court, galvanized steel structure length 200 cm, equipped with 4 polypropylene coloured seats

S04912

Panchina bordo campo tennis, struttura in acciaio zincato lunghezza cm 100 con nr 2 scocche di seduta in polipropilene colorato

Bench for tennis court, galvanized steel structure length 100 cm, equipped with 2 polypropylene coloured seats

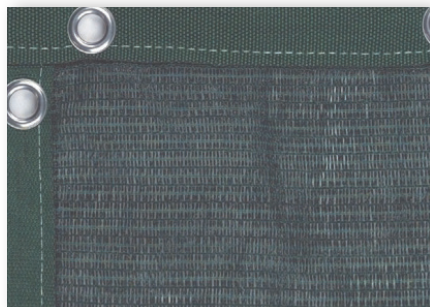
**S04914**

Telo fondo campo per campi tennis, colore verde, dimensioni mt 18x2

Green colour boundary sheet for tennis court, dimensions 18x2 mt

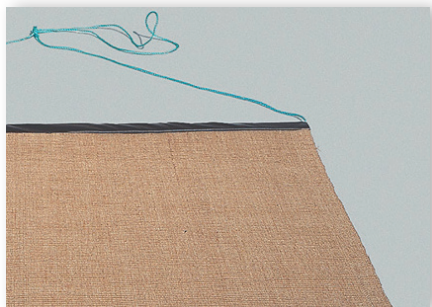
**S04916**

Stuoia livellatrice per campo tennis in cocco con asta di ferro

Levelling coconut net for tennis court with steel bar

**S04918**

Fettuccia segna campo tennis in rotoli da mt 150

Tennis court line marking tape in rolls of 150 mt

S04920

Rete di protezione per campo tennis in polietilene verde, diametro mm 3, maglia cm 4,5x4,5 senza nodo
Protective net for tennis court made of green polyethylene, diameter 3 mm, mesh 4.5x4.5 cm without knots

S04921

Bordatura perimetrale per rete di protezione per campo tennis S04920
Bording cord for protective net for tennis court S04920



S04924

S04926

S04924

Racchetta tennis in grafite Babolat
Graphite composition Babolat racket

S04926

Confezione di 3 palline tennis
Box with 3 tennis balls



S04930

S04930

Macchina spara-palline Lobster Elite 1 per allenamento al tennis
Lobster Elite 1 balls shooting machine for tennis training sessions



S04932

S04932

Tabellone elettronico segnapunti portatile, da tavolo, per il tennis, incluso pannello di controllo integrato sul retro. Completo di batteria e carica-batteria
Portable desktop electronic scoreboard for tennis, including control panel integrated on back side. Supplied with battery and battery's charger

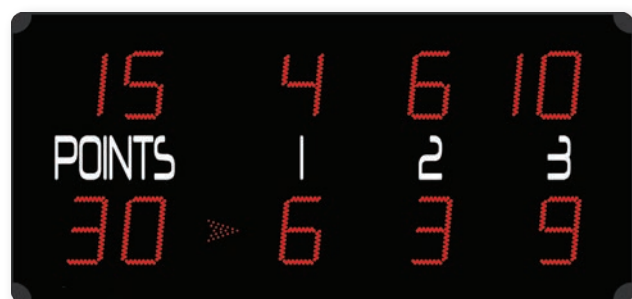
**S04934****NEW**

Tabellone elettronico segnapunti tennis per esterno, 452RTX, dimensioni cm 150x70. Completo di console
Outdoor electronic scoreboard for tennis, 452RTX, dimensions cm 150x70. Including control panel

S04936**NEW**

Tabellone elettronico segnapunti tennis per esterno, 452RTX ALPHA con visualizzazione nomi giocatori, dimensioni cm 240x70. Completo di console
Outdoor electronic scoreboard for tennis, 452RTX ALPHA visualizing players' names, dimensions cm 240x70. Including control panel

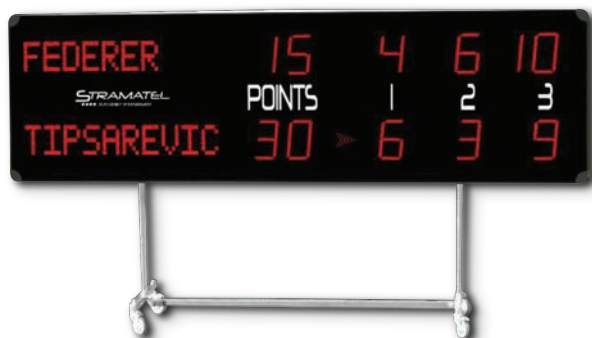

S04937

S04937**NEW**

Carrello per sostegno e trasporto tabelloni elettronici segnapunti tennis per esterno
Wheeled stand for storing and moving outdoor electronic scoreboard for tennis

21

Badminton

133 / 210

S04940

**S04940**

Coppia pali badminton in acciaio verniciato con basi zavorrabili, mobili su ruote, facilmente smontabili
Pair of freestanding badminton posts made of varnished steel, bases to be filled, mobile on wheels, demountable

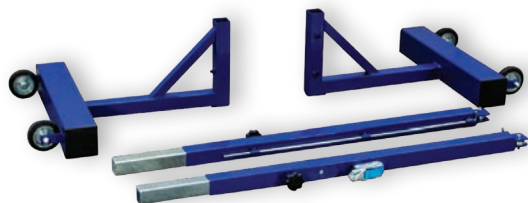

S04941

S04941

Coppia pali badminton professionali in acciaio verniciato con basi zavorrabili, mobili su ruote, facilmente smontabili, regolabili in altezza e completi di tendirete
Pair of freestanding professional badminton posts made of varnished steel, bases to be filled, mobile on wheels, demountable, height adjustable and complete of net tensioner device

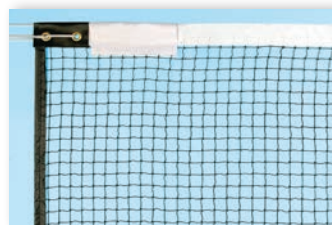
**S04942**

Rete per badminton in nylon, lunghezza cm 610
Net for badminton made of nylon, length 610 cm

**S04944**

Racchetta per badminton regolamentare in lega di carbonio ed alluminio
Badminton racket made of carbon and aluminium

**S04946**

Volano per badminton in nylon, in confezione da 12 pezzi
Nylon shuttlecock for badminton, in box of 12 pieces

22

Articoli per beach handball e beach soccer
Beach handball and beach soccer equipment

S05002

S05002**NEW**

Coppia porte beach handball in alluminio verniciato colore blu, diametro mm 80, dimensioni cm 300x200
Pair of blue colour aluminium beach handball goals, round section 80 mm, dimensions 300x200 cm

S05004

Coppia reti beach handball in nylon
Pair of nets for beach handball made of nylon

S05006

Serie nastri demarcazione campo beach handball con picchetti
Set of beach handball courtlines with pickets

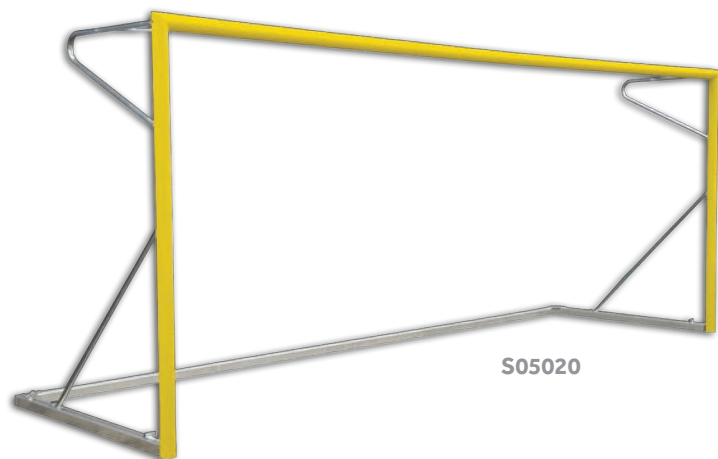

S05020

S05020



Coppia porte beach soccer in alluminio verniciato colore giallo, diametro mm 80, dimensioni cm 550x220
Pair of yellow colour aluminium beach soccer goals, round section 80 mm, dimensions 550x220 cm

S05022

Coppia reti beach soccer in nylon
Pair of nets for beach soccer made of nylon

S05024

Serie nastri demarcazione campo beach soccer con picchetti
Set of beach soccer courtlines with pickets

23

Articoli per beach volley e beach tennis *Beach volley and beach tennis equipment*



S05052

S05054

Impianto beach volley e beach tennis monotubolare in acciaio zincato a freddo, con bussole maggiorate e dispositivo tendirete
Cold galvanized steel monotubular beach volley and beach tennis system with longer ground sockets and net tensioner



S05054



S05052

Set beach volley per uso ricreativo costituito di pali componibili con tiranti e rete, trasportabile su sacca
Recreational beach volley set transportable on bag including stackable posts and net

S05056

Impianto beach volley e beach tennis monotubolare in acciaio zincato a caldo, con bussole maggiorate e dispositivo tendirete
Hot-dip galvanized steel monotubular beach volley and beach tennis system with longer ground sockets and net tensioner



S05060

S05060

Coppia protezioni imbottite per impianto beach volley e beach tennis S05054 e S05056
Pair of protective pads for beach volley and beach tennis system S05054 and S05056

SPORT SYSTEM



S05062

S05062

Serie nastri demarcazone campo beach volley e beach tennis (mt 16x8) con picchetti

Set of beach volley and beach tennis courtlines (16x8 mt) with pickets

**S05063**

Rete beach volley in nylon con banda perimetrale in polipropilene

Net for beach volley made of nylon with polypropylene edges

**S05064**

Rete beach volley professionale in nylon con banda perimetrale in PVC, antenne comprese

Professional net for beach volley made of nylon with PVC edges, including antennas

**S05066**

Rete beach tennis in nylon con banda perimetrale in PVC

Net for beach tennis made of nylon with PVC border



S05068

S05068

Palchetto per arbitro beach volley con struttura di acciaio zincato

Beach volley referee platform made of galvanized steel



S05070

S05070

Palchetto per arbitro beach volley in acciaio zincato, agganciabile al palo, dotato di protezione frontale

Beach volley referee platform made of galvanized steel, with front protective pad, to be fixed to post



NEW

NOTE

136 / 210



Linea completa di attrezzi e accessori beach volley, omologati FIVB, per competizioni internazionali.

Complete range of beach volley equipment and accessories, FIVB approved, for international competitions.

S05080

FIVB approved

Impianto beach volley monotubolare in alluminio verniciato con bussole e dispositivo tendirete, omologato FIVB per competizioni internazionali

Varnished aluminium beach volley system with ground sleeves and net tensioner, FIVB approved for international competitions

S05080

**S05082**

FIVB approved

Coppia protezioni imbottite per impianto beach volley omologato FIVB
Pair of protective pads for beach volley system FIVB approved

S05082



S05086

S05084

FIVB approved

Rete beach volley completa di antenne, omologata FIVB per competizioni
Beach volley net with antennas, FIVB approved for competition

S05084

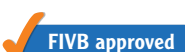
**S05086**

FIVB approved

Palchetto per arbitro beach volley, omologato FIVB per competizioni, completo di imbottiture
Beach volley referee platform, FIVB approved for competitions, included protective pads

S05088

**S05088**

FIVB approved

Serie nastri demarcazione campo beach volley con accessori, omologati FIVB
Set of beach volley courtlines with accessories, FIVB approved for competitions





Sport System presenta una linea completa di strutture per lo streetball, conosciuto anche come **3ON3** ... dalla soluzione più semplice, fissa a terra, passando per la soluzione mobile su ruote scelta anche da **FIBA Europe**, fino ad arrivare al modello S05109.

Sport System presents a complete line of units for the ever more popular streetball, also known as **3ON3** ... from the most cost effective in-ground model to the portable unit selected by **FIBA Europe**, until the last developed model S05109.



S05102

S05102

Struttura streetball monotubolare di acciaio zincato, sbalzo cm 225, tabellone di resina melamminica su telaio con tirante di rinforzo, canestro fisso e retina

Monotubular streetball backstop, galvanized steel structure projection 225 cm, hpl backboard on steel frame with reinforcing tie bar, fixed ring and net

S05104

**S05104**

Struttura streetball richiudibile e trasportabile in acciaio verniciato, base porta zavorra, tabellone in resina, canestro fisso e retina, protezione frontale

Foldable and portable streetball unit entirely in varnished steel, platform supporting ballast, hpl backboard, fixed ring with net, front protection pad

S05106 ✓ **EN1270 tested**

Struttura streetball Easyplay College in acciaio zincato mobile su ruote, sbalzo cm 125, sistema meccanico a manovella di regolazione dell'altezza, tabellone di resina melamminica su telaio, canestro fisso e retina

Easyplay College galvanized steel portable streetball backstop mobile on wheels, projection 125 cm, mechanical height adjustment, hpl backboard on steel frame, ring and net



S05106

NOTE

La struttura streetball Easyplay College è disponibile anche con tabellone in plexiglas trasparente completo di protezione (S04206), canestro reclinabile (S04234) con retina e protezioni laterali della base, a richiesta.

Easyplay College streetball backstop can be equipped as well with transparent acrylic backboard with pad (S04206), reclining ring (S04234) with net and soft cushions on sides of the base, on demand.

**S05108**

Struttura Hydroplay Club personalizzata 3ON3, interamente in acciaio zincato con carter posteriore anti-vandalismo; indicatore contasecondi integrato nella protezione frontale con copertura in policarbonato, completo di pulsantiera di comando; incluso set fodere anti-pioggia e pedana di supporto per zavorra aggiuntiva

Hydroplay Club portable unit customized 3ON3, entirely made in galvanized steel with rear anti-vandalism shell; shot clock integrated in the main front pad, including control panel and polycarbonate cover; set of rain covers and platform supporting extra ballast included



**S05109**

Struttura Hydroplay Ace personalizzata 3ON3 interamente in acciaio zincato con braccio ricurvo avente sbalzo totale cm 225; carter posteriore di protezione del sistema idraulico di movimentazione; indicatore contasecondi integrato nella protezione frontale con copertura in policarbonato, completo di pulsantiera di comando; pedana di supporto per zavorra aggiuntiva

Hydroplay Ace portable unit customized 3ON3 entirely realized in galvanized steel with curved main arm having total projection 225 cm; rear shell protecting the oleodynamic movement unit; shot clock integrated in the main front pad under a polycarbonate shell, complete of control panel; platform supporting extra ballast

**NOTE**

Per realizzare un campo completo 3ON3 Sport System propone anche pavimentazione, tabellone elettronico e tribuna.

Complete your 3ON3 courts with modular floor, electronic scoreboard and compact stand by Sport System.

**S05110**

Pavimentazione modulare per basket outdoor 3ON3, in piastrelle di polipropilene colorato stabilizzato ai raggi UV, facilmente posabile e rimovibile, utilizzabile anche per altri sport

Portable modular floor for outdoor basket 3ON3, made of 25x25 cm polypropylene tiles UV resistant, easy to install and remove, useful for other different sports as well



**S05391****NEW**

Tabellone elettronico multisport portatile da tavolo per uso esterno, MULTITOP X12, dimensioni cm 73x37, incluso pannello di controllo integrato sul retro e pulsantiera per gestione 12/24 secondi

Tabletop portable electronic multisport scoreboard for outdoor use, MULTITOP X12, dimensions 73x37 cm, including control panel integrated on backside and shot clock controller

**S07682**

Modulo tribuna per esterno in acciaio zincato e verniciato con scala di accesso e 2 file di sedute a scocche di polipropilene per un totale di 7 posti, con personalizzazione 3ON3

Compact stand for outdoor use entirely made in galvanized and painted steel with stairways and walkways, 2 steps with total 7 places equipped with polypropylene seats, customized 3ON3

REFERENZE

ITALY



AUSTRIA



CYPRUS

REFERENCES

BULGARIA



SLOVENIA

REFERENZE

REFERENCES



BELARUS



GEORGIA



SWITZERLAND



RUSSIA



SPAIN



ITALY

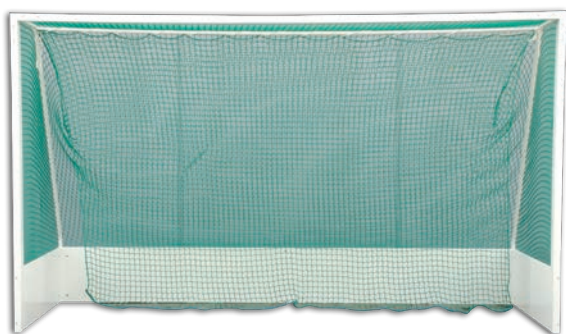

S05122

S05122

Coppia porte regolamentari in legno e acciaio verniciato per hockey su prato
Pair of standard goals for field hockey made of wood and varnished steel

**S05124**

Coppia reti in nylon per porte hockey su prato
Pair of nylon nets for field hockey goals



S05126

S05126

Coppia ruote gommata per trasporto porte hockey su prato
Pair of rubber wheels for field hockey goals



S05128

S05128

Coppia porte regolamentari in acciaio verniciato per hockey su pista
Pair of standard goals for roller hockey made of varnished steel

**S05130**

Coppia reti in nylon per porte hockey su pista
Pair of nylon nets for roller hockey



S05132

S05132

Coppia porte unihockey in acciaio con reti, dimensioni cm 150x110
Pair of unihockey goals made of steel with net, dimensions 150x110 cm

**S05134**

Set unihockey composto di 6 + 6 bastoni e 3 palline
Unihockey set made of 6 + 6 sticks and 3 balls

S05135

Pallina in plastica bianca per unihockey
White plastic ball for unihockey

**S05142**

Coppia porte rugby regolamentari in alluminio, con bussole, altezza fuori terra mt 11

Pair of aluminium rugby goals with ground sockets, height 11 mt over ground level

S05144

Set completo protezioni imbottite per porte rugby

Complete set of protective pads for pair of rugby goals



S05152

**S05152**

Mazza da baseball regolamentare in legno
Standard wooden baseball bat

S05154

**S05154**

Mazza da baseball regolamentare in alluminio
Standard aluminium baseball bat

**S05156**

Palla baseball rivestita in pelle sintetica
Baseball ball covered by synthetic leather

**S05158**

Guantone baseball in pelle sintetica
Synthetic leather baseball glove

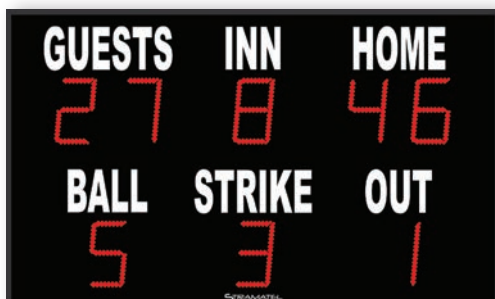
**S05160****NEW**

Tabellone elettronico segnapunti baseball per esterno, 452 FBB, dimensioni cm 190x115. Completo di console
Outdoor electronic scoreboard for baseball, 452 FBB, dimensions 190x115 cm. Including control panel

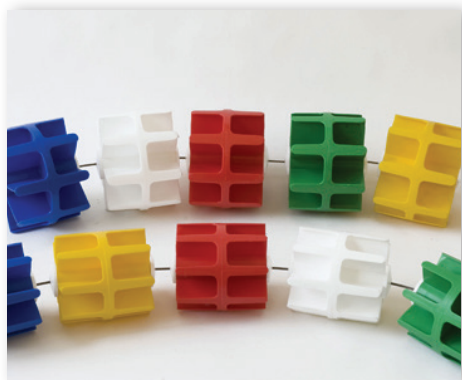
**S05172**

Corsia frangionda galleggiante con elementi in polipropilene colorato, diametro mm 110, completa di cavo, tenditore e molla, lunghezza mt 25
Swimming pool floating lane with colored polypropylene elements, diameter 110 mm, complete of cable, spring and hooks, length 25 mt

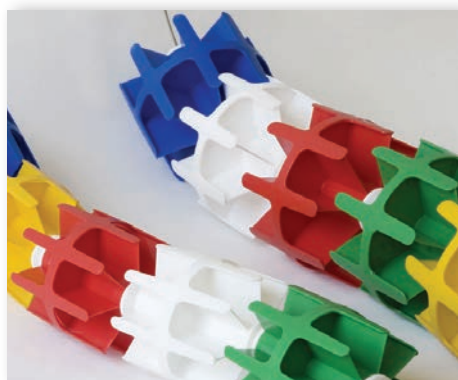
**S05174**

Corsia frangionda galleggiante con elementi in polipropilene colorato, diametro mm 110, completa di cavo, tenditore e molla, lunghezza mt 50
Swimming pool floating lane with colored polypropylene elements, diameter 110 mm, complete of cable, spring and hooks, length 50 mt

**S05176**

Carrello avvolgi corsie con struttura in acciaio inox, mobile su ruote girevoli
Floating lanes storage trolley made of stainless steel, mobile on wheels

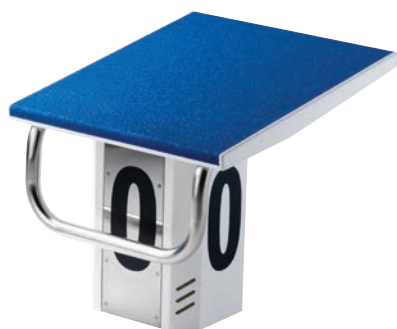
**S05178**

Blocco di partenza per piscina, in acciaio inox, piatto con superficie antiscivolo e maniglione
Swimming pool starting block made of stainless steel, anti-slip board's surface, with handle

**S05180**

Pull buoy monoblocco in EVA per esercizi di apprendimento
Pull buoy made of EVA, for training exercises

S05182

Tavoletta nuoto monoblocco in EVA per esercizi di apprendimento
Swimming board made of EVA, for training exercises

**S05184**

Cilindro galleggiante in polietilene espanso, diametro cm 7 lunghezza cm 160
Floating stick made of polyethylene, diameter 7 cm length 160 cm

**S05186**

Connettore a due fori per cilindro galleggiante, in polietilene espanso
Two holes connecting tube for floating stick, made of polyethylene

**S05188**

Occhialino nuoto monoblocco, finitura antifog
Swimming pool goggle antifog

**S05190**

Cuffia nuoto in gomma colorata, misura senior
Coloured rubber swimming pool cap, size senior

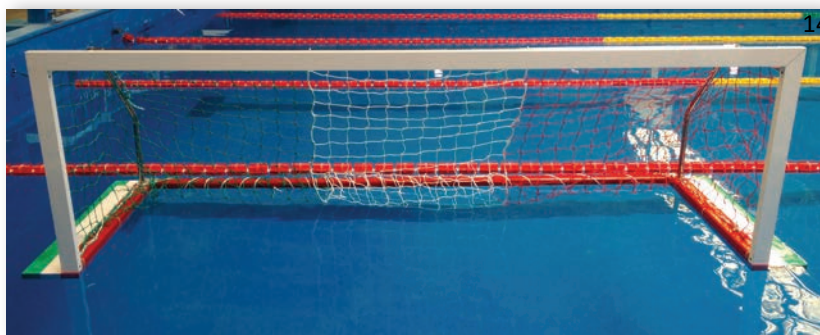
**S05192**

Coppia porte pallanuoto regolamentari in alluminio con base galleggiante

Pair of standard aluminium goals for water polo with floating base

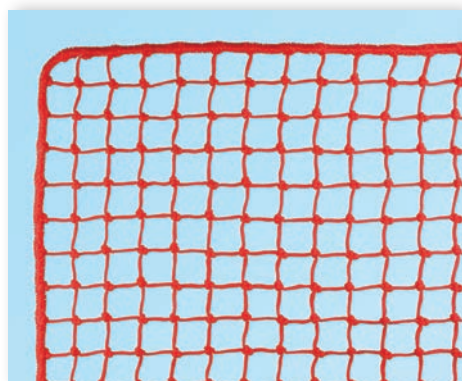
**S05194**

Coppia reti in polietilene diametro mm 5 per porte pallanuoto

Pair of polyethylene nets diameter 5 mm for water polo goals

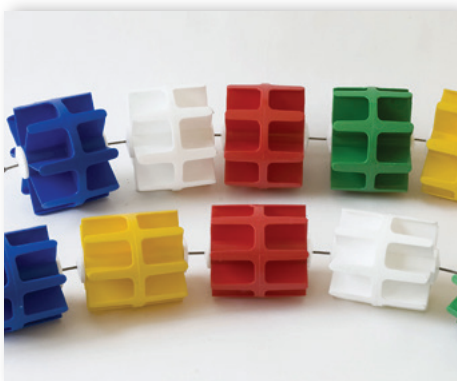
**S05196**

Set corsie galleggianti per demarcazione campo pallanuoto regolamentare su piscina da mt 50
Set of floating lanes for marking water polo playfield on 50 mt long swimming pool

**S05198**

Set 13 cuffie pallanuoto numerate
Set of 13 water polo caps numbered

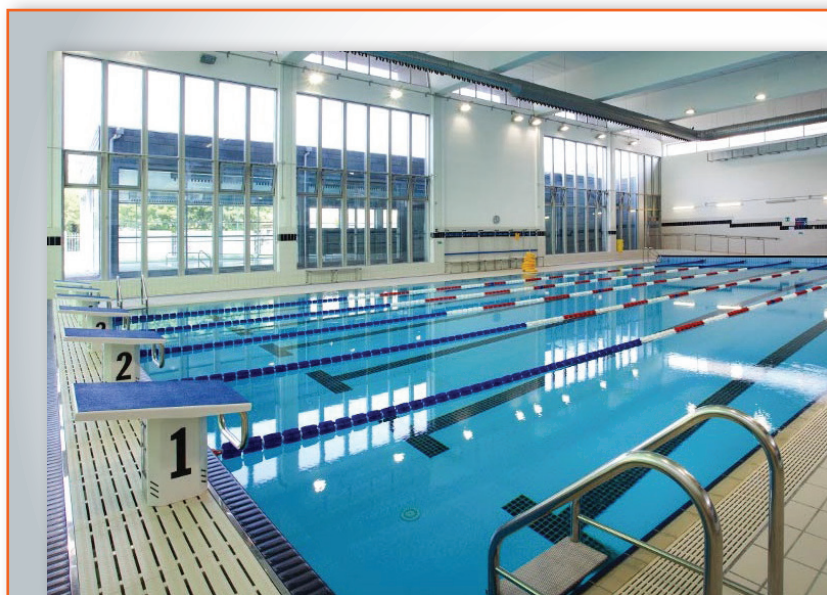
**NOTE**

A richiesta Sport System può fornire una linea completa di attrezzature ed arredi per il piano vasca, **100% Made in Italy.**

On demand Sport System can supply a complete range of equipment and furniture for the swimming pool basin, **100% Made in Italy.**

S05202

**S05202**

Set multifunzione ricreativo per gioco volley, minivolley e tennis composto di 2 strutture con base zavorrabile, mobili su ruote.

Rete esclusa

Multipurpose recreational set for volley, minivolley and tennis made of 2 freestanding portable structures with base to be filled, mobile on wheels.
Net not included

S05206

**S05206**

Impianto multifunzione professionale volley, minivolley, tennis e salto in alto composto di 2 strutture mobili su ruote con base zavorrata in acciaio zincato, palo di alluminio e cursore scorrevole. Rete esclusa

Multipurpose professional set for volley, minivolley, tennis and high jump made of 2 stands with heavy galvanized steel base mobile on wheels, aluminium post, adjustable support for net or crossbar.
Net not included

S05208

**S05208**

Coppia tabelloni di plastica con canestro su supporto in acciaio verniciato per impianto multifunzione S05206

Pair of plastic backboards with ring, mounted on steel frame, for multipurpose stands S05206

S05209

Set completo di protezioni imbottite per impianto multifunzione professionale S05206

Complete set of protective pads for multipurpose professional set S05206



S05209

S05210

**S05210**

Rete per impianto multifunzione professionale, dimensioni mt 9x1

Net for professional multipurpose stands, dimension 9x1 mt



S05212

S05212

Coppia strutture netball mobili su ruote con canestri ad altezza regolabile, basi zavorrate in acciaio, pali in due elementi di acciaio zincato a sezione quadrata, protezioni con altezza cm 200 in gomma espansa rivestita

Pair of netball units mobile on wheels with ring adjustable in height, heavy bases made of steel, square section galvanized steel posts made of two elements, protective pads with height 200 cm

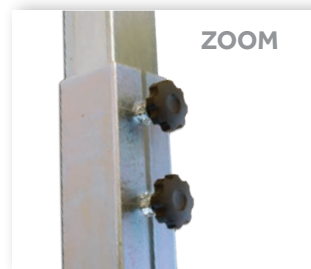

S05214

S05214

Coppia strutture netball professionali con canestri ad altezza fissa, sostegni in acciaio verniciato diametro mm 60, bussole da cementare, protezioni in gomma espansa rivestita con altezza cm 300 e diametro esterno cm 20

Pair of professional netball units with rings at fixed height, varnished steel posts round section 60 mm, ground sockets, protective pads with height 300 cm and outside diameter 20 cm





S05222

S05222

Tavolo tennis per interno pieghevole e mobile su ruote, completo di sostegni e retina

Indoor tennis table foldable and movable on wheels, including net set



S05226

S05226

Tavolo tennis per esterno pieghevole e mobile su ruote, telaio di supporto rinforzato, completo di sostegni e retina

Outdoor tennis table foldable and movable on wheels, reinforced frame profile, including net set



S05228

S05228

Tavolo tennis per interno pieghevole e mobile su ruote, telaio di supporto rinforzato, completo di sostegni e retina, omologato ITTF

Indoor tennis table foldable and movable on wheels, reinforced frame profile, including net set, ITTF approved

**S05230**

Coppia di sostegni metallici con retina in nylon per tavolo tennis

Pair of metal net supports with nylon net for table tennis

**S05232**

Retina in nylon per tavolo tennis

Nylon net for table tennis

**S05234**

Racchetta per tennis tavolo con gomma liscia su ambo i lati

Table tennis bat with smooth rubber on both sides

**S05236**

Confezione di 6 palline per tennis tavolo bianche o gialle

Box with 6 table tennis balls white or yellow



S05238

S05238

Segnapunti manuale da tavolo

Portable desk scoreboard for table tennis

S05240

Robot spara-palline Joola Shorty funzionale ad un allenamento completo al tennis tavolo

Robot Joola Shorty functional for a complete training on table tennis



S05240



S05252

S05252

Calciobalilla senza gettoniera, gambe in acciaio verniciato, scocca di multistrato, aste cromate

Football table without coins slot, varnished steel legs, chipboard body, chromed rods



S05254

S05254

Calciobalilla con gettoniera, gambe in acciaio, scocca di multistrato, aste cromate

Football table with coins slot, varnished steel legs, chipboard body, chromed rods



S05262

S05262

Carambola senza gettoniera, struttura di legno, piano di gioco in ardesia cm 180x90, incluso set accessori

Pool table without coins slot, wooden structure, slate playing surface 180x90 cm, including set of accessories

S05264

Carambola con gettoniera, struttura rinforzata, piano di gioco in ardesia cm 200x100, incluso set accessori

Pool table with coins slot, reinforced structure, slate playing surface 200x100 cm, including set of accessories



S05264

NEW

Sport System presenta una **LINEA** completa di tabelloni elettronici multisport, dalla soluzione più semplice alle alternative omologate **FIBA**.

Sport System presents a complete **LINE** of multisport electronic scoreboards, from the simplest one up to the most professional alternatives **FIBA** approved.

S05300

Console di comando 700, multisport con display touchscreen per gestione tabelloni elettronici FC e FS. Completa di trasmettitore radio

Touchscreen multisport control panel 700, with radio transmitter integrated, suitable to control electronic scoreboards FC and FS



S05300

**S05301**

Pulsantiera "time-console-03" collegabile alla console multisport per gestione degli indicatori 24'

"Time-console-03" keyboard to be connected to control panel 700, suitable to control 24' shot clocks



S05301

S05302

Valigetta in plastica per contenimento console di comando multisport ed eventuali pulsantiere "time-console-03"

Plastic case for control panel 700 and "time-console-03" keyboards



S05302

**S05303**

Tabellone elettronico multisport portatile da tavolo PS-M, dimensioni cm 55x35, incluso pannello di controllo integrato sul retro

Tabletop portable electronic multisport scoreboard PS-M, dimensions 55x35 cm, including control panel integrated on back side

NOTE

Attenzione: tabelloni forniti privi di console di comando, da ordinare separatamente.

Attention: electronic scoreboards supplied without control panel to be ordered separately.

**S05306**

Tabellone elettronico multisport FC50H15, dimensioni cm 90x60, trasmissione radio, altezza cifre cm 15
 Multisport electronic scoreboard FC50H15, dimensions 90x60 cm, radio transmission, digits height 15 cm

**S05307**

Tabellone elettronico multisport FC50H20, dimensioni cm 140x75, trasmissione radio, altezza cifre cm 20
 Multisport electronic scoreboard FC50H20, dimensions 140x75 cm, radio transmission, digits height 20 cm

**S05308**

Tabellone elettronico multisport FC50H25, dimensioni cm 140x85, trasmissione radio, altezza cifre cm 25
 Multisport electronic scoreboard FC50H25, dimensions 140x85 cm, radio transmission, digits height 25 cm

**S05309**

Tabellone elettronico multisport FC50H25N con nomi squadre programmabili, dimensioni cm 140x110, trasmissione radio, altezza cifre cm 25
 Multisport electronic scoreboard FC50H25N with programmable teams' name, dimensions 140x110 cm, radio transmission, digits height 25 cm

**S05310**

Tabellone elettronico multisport FC54H25N12A1 con nomi squadre programmabili e falli dei singoli giocatori, dimensioni cm 240x145, trasmissione radio, altezza cifre cm 25
 Multisport electronic scoreboard FC54H25N12A1 with programmable teams' name and personal fouls, dimensions 240x145 cm, radio transmission, digits height 25 cm

**S05311**

Tabellone elettronico multisport FC62H25N12B2 con nomi squadre programmabili, numero e falli dei singoli giocatori, penalità, dimensioni cm 260x200, trasmissione radio, altezza cifre cm 25

Multisport electronic scoreboard FC62H25N12B2 with programmable teams' name, number and personal fouls, penalties, dimensions 260x200 cm, radio transmission, digits height 25 cm

**S05316**

Tabellone elettronico multisport FS110, dimensioni cm 200x120, trasmissione via cavo

Multisport electronic scoreboard FS110, dimensions 200x120 cm, cable transmission

**S05318**

Tabellone elettronico come S05316, trasmissione via radio

Multisport electronic scoreboard as S05316, radio transmission

S05320

Tabellone elettronico multisport FS110N con nomi squadre programmabili, dimensioni cm 200x120, trasmissione via cavo

Multisport electronic scoreboard FS110N with programmable teams' name, dimensions 200x120 cm, cable transmission

S05322

Tabellone elettronico come S05320, trasmissione via radio

Multisport electronic scoreboard as S05320, radio transmission

Attenzione: gli articoli S05316, S05318, S05320, S05322 non visualizzano i falli di squadra per il basket.

Attention: articles S05316, S05318, S05320, S05322 do not show team's fouls for basket.

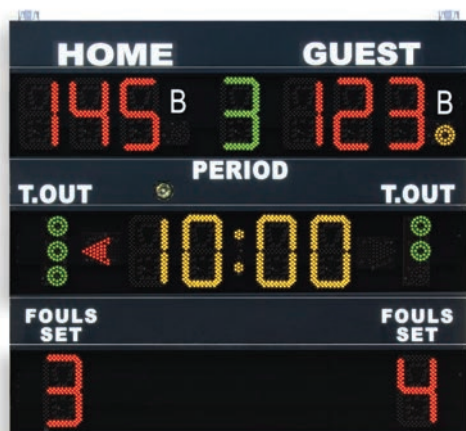
NOTE**S05324**

Tabellone elettronico multisport FS120 con visualizzazione falli/set, dimensioni cm 200x180, trasmissione via cavo

Multisport electronic scoreboard FS120 visualizing fouls/set, dimensions 200x180 cm, cable transmission

S05326

Tabellone elettronico come S05324, trasmissione via radio

Multisport electronic scoreboard as S05324, radio transmission

S05328 ✓ FIBA - Level 2

Tabellone elettronico multisport FS120N con nomi squadre programmabili e visualizzazione falli/set, dimensioni cm 200x180, trasmissione via cavo

Multisport electronic scoreboard FS120N with programmable teams' name and visualization of fouls/set, dimensions 200x180 cm, cable transmission

S05330 ✓ FIBA - Level 2

Tabellone elettronico come S05328, trasmissione via radio

Multisport electronic scoreboard as S05328, radio transmission

S05332

Tabellone elettronico multisport FS130 con visualizzazione dettagli ultimo fallo (nr giocatore e nr fallo personale), dimensioni cm 200x180, trasmissione via cavo

Multisport electronic scoreboard FS130 visualizing details of last foul (nr of player and nr of personal foul), dimensions 200x180 cm, cable transmission

S05334

Tabellone elettronico come S05332, trasmissione via radio

Multisport electronic scoreboard as S05332, radio transmission

S05336 ✓ FIBA - Level 2

Tabellone elettronico multisport FS130N con nomi squadre programmabili e visualizzazione dettagli ultimo fallo (nr giocatore e nr fallo personale), dimensioni cm 200x180, trasmissione via cavo

Multisport electronic scoreboard FS130N with programmable teams' name and visualization of details of last foul (nr of player and nr of personal foul), dimensions 200x180 cm, cable transmission

S05338 ✓ FIBA - Level 2

Tabellone elettronico come S05336, trasmissione via radio

Multisport electronic scoreboard as S05336, radio transmission

S05340

Tabellone elettronico FS140 per la visualizzazione di due tempi di penalità per squadra, dimensioni cm 200x100, integrabile ad un qualsiasi tabellone elettronico della linea FS

Electronic scoreboard FS140 displaying two penalty times per team, dimensions 200x100 cm, to be connected to FS line main scoreboard

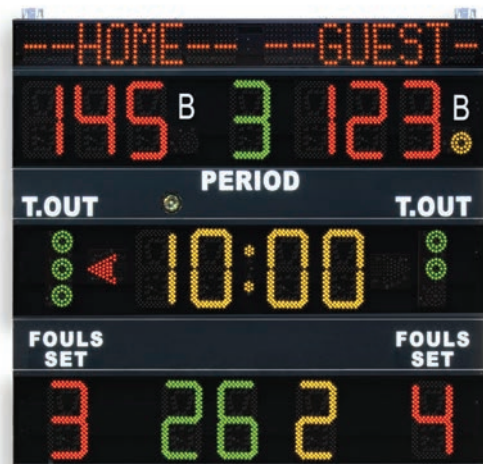
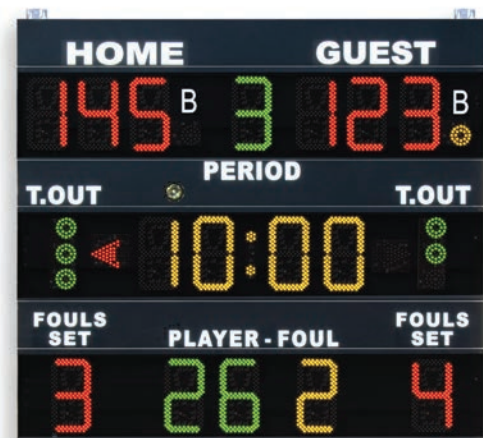
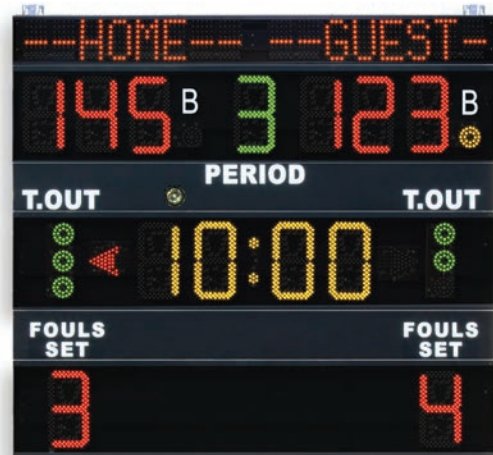

**S05342**

Tabellone elettronico FS150 per la visualizzazione di tre tempi di penalità per squadra, dimensioni cm 200x140, integrabile ad un qualsiasi tabellone elettronico della linea FS
Electronic scoreboard FS150 displaying three penalty times per team, dimensions 200x140 cm, to be connected to FS line main scoreboard

**S05346**

Tabellone elettronico FS160 per la visualizzazione dei punteggi dei set per la pallavolo, dimensioni cm 200x60, integrabile ad un qualsiasi tabellone della linea FS
Electronic scoreboard FS160 visualizing sets' results for volley, dimensions 200x60 cm, to be connected to FS line main scoreboard

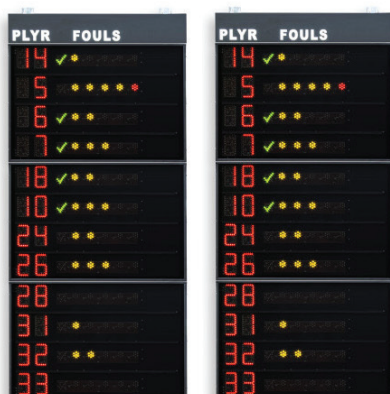
**S05350**

Coppia guanciale laterali FS-412B con visualizzazione nr di maglia di 12 giocatori (programmabili) e falli personali a punti luminosi, dimensione di ciascun guanciale cm 120x260
Pair statistics panels FS-412B visualizing 12 players' number (programmable) and personal fouls by luminous points, dimensions of each panel 120x260 cm

**S05352**

Coppia guanciale laterali FS-414B con visualizzazione nr di maglia di 14 giocatori (programmabili) e falli personali a punti luminosi, dimensione di ciascun guanciale cm 120x320
Pair statistics panels FS-414B visualizing 14 players' number (programmable) and personal fouls by luminous points, dimensions of each panel 120x320 cm

**S05354**

Coppia guanciale laterali FS-412C con visualizzazione nr di maglia di 12 giocatori (programmabili), falli personali a punti luminosi e punteggio, dimensione di ciascun guanciale cm 120x260
Pair statistics panels FS-412C visualizing 12 players' number (programmable), personal fouls by luminous points and personal score, dimensions of each panel 120x260 cm

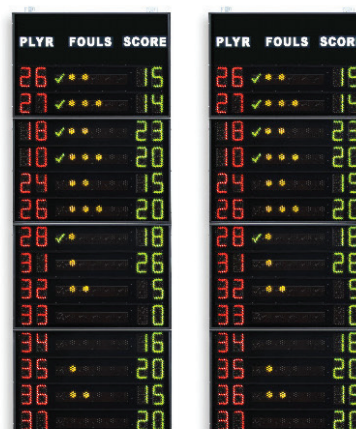
**S05356**

Coppia guanciale laterali FS-414C con visualizzazione nr di maglia di 14 giocatori (programmabili), falli personali a punti luminosi e punteggio, dimensione di ciascun guanciale cm 120x320
Pair statistics panels FS-414C visualizing 14 players' number (programmable), personal fouls by luminous points and personal score, dimensions of each panel 120x320 cm

**S05366**

Coppia guanciaie laterali FS-412F con visualizzazione nome programmabile di 12 giocatori a 12 caratteri, dimensioni di ciascun guanciaie cm 145x240
Pair side panels FS-412F visualizing 12 players' name, programmable with 12 characters, dimensions of each panel 145x240 cm

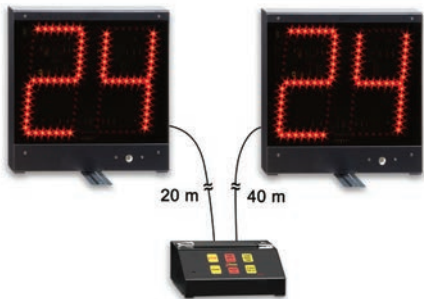
**S05370**

Kit 24/14" composto di nr 2 indicatori dimensioni cm 30x30 con cifre altezza cm 20 ed una pulsantiera di comando, trasmissione via cavo, valori programmabili
KIT 24/14" composed of 2 shot clocks dimensions 30x30 cm with 20 cm high digits and control panel, cable transmission, programmable values

S05372

Coppia indicatori 24/14" WSC-24s con batteria ricaricabile, da appoggiare a terra, dimensioni cm 30x32, collegabili alla console del tabellone elettronico principale, trasmissione radio

Pair of 24/14" shot clocks WSC-24s self-standing with rechargeable battery, dimensions 30x32 cm, to be connected to main scoreboard's control panel, radio transmission

**S05374**

Coppia indicatori 24/14" FS-24S-H20 dimensioni cm 40x30 con cifre altezza cm 20, collegabili alla console del tabellone elettronico principale o funzionante con console S05375, trasmissione via cavo

Pair of 24/14" shot clocks FS-24S-H20 dimensions 40x30 cm with 20 cm high digits, to be connected to main scoreboard's control panel or to control panel S05375, cable transmission

**S05375**

Console di comando per utilizzo dell'articolo S05374 anche in assenza di tabellone elettronico principale

Control panel for using article S05374 even without any main scoreboard

**S05376**

Coppia indicatori 24/14" come S05374, trasmissione radio

Pair of 24/14" shot clocks as S05374, radio transmission



S05378 ✓ FIBA - Level 2

Coppia indicatori 24/14" monofacciali FS-24S-1B con visualizzazione tempo di gioco, dimensioni cm 70x60, collegabili alla console del tabellone elettronico principale, trasmissione via cavo

Pair of 24/14" single-face shot clocks FS-24S-1B visualizing game's time, dimensions 70x60 cm, to be connected to main scoreboard's control panel, cable transmission

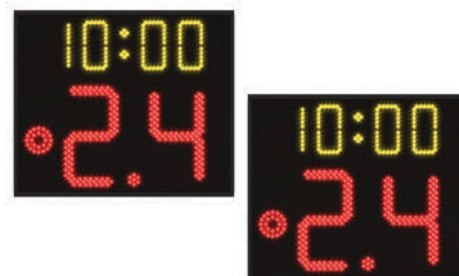
**S05380** ✓ FIBA - Level 2

Coppia indicatori 24/14" come S05378, trasmissione radio

Pair of 24/14" shot clocks as S05378, radio transmission

S05382 ✓ FIBA - Level 2

Coppia indicatori 24/14" trifacciali FS-24S-3B con visualizzazione tempo di gioco, dimensioni cm 70x60, collegabili alla console del tabellone elettronico principale, trasmissione via cavo

Pair of 24/14" three-faces shot clocks FS-24S-3B visualizing game's time, dimensions 70x60 cm, to be connected to main scoreboard's control panel, cable transmission

**S05384** ✓ FIBA - Level 2

Coppia indicatori 24/14" come S05382, trasmissione radio

Pair of 24/14" shot clocks as S05382, radio transmission

S05386 ✓ FIBA - Level 2

Coppia indicatori 24/14" quadrifacciali FS-24S-4B con visualizzazione tempo di gioco, dimensioni cm 70x60, collegabili alla console del tabellone elettronico principale, trasmissione via cavo

Pair of 24/14" four-faces shot clocks FS-24S-4B visualizing game's time, dimensions 70x60 cm, to be connected to main scoreboard's control panel, cable transmission

**S05388** ✓ FIBA - Level 2

Coppia indicatori 24/14" come S05386, trasmissione radio

Pair of 24/14" shot clocks as S05386, radio transmission

S05390

Display LED per ambiente sportivo indoor con funzione promozionale e comunicativa, dimensioni cm 300x200. Fornito con struttura di supporto e sistema di controllo

LED display for indoor sports hall with promotional and communication functions, dimensions 300x200 cm.

Supplied with supporting structure and control system



LINEA PER ESTERNO - OUTDOOR LINE

S05391

NEW

Tabellone elettronico multisport portatile da tavolo per uso esterno, MULTITOP X12, dimensioni cm 73x37, incluso pannello di controllo integrato sul retro e pulsantiera per gestione 12/24 secondi

Tabletop portable electronic multisport scoreboard for outdoor use, MULTITOP X12, dimensions 73x37 cm, including control panel integrated on backside and shot clock controller



S05393

NEW

Tabellone elettronico multisport per uso esterno, 452XME3000, dimensioni cm 120x65, trasmissione via radio, compresa console di comando

Electronic multisport scoreboard for outdoor use, 452XME3000, dimensions 120x65 cm, radio transmission, including control panel



S05395

NEW

Tabellone elettronico per uso esterno, 452 FRB, per calcio, rugby e hockey, dimensioni cm 180x100, trasmissione via radio, compresa console di comando

Electronic scoreboard for outdoor use, 452 FRB, for football, rugby and hockey, dimensions 180x100 cm, radio transmission, including control panel



S05397

NEW

Tabellone elettronico per uso esterno, 452 FRB AD, per calcio, rugby e hockey, visualizzazione del nome delle squadre o messaggi in movimento, dimensioni cm 200x100, trasmissione via radio, compresa console di comando

Electronic scoreboard for outdoor use, 452 FRB AD, for football, rugby and hockey, programmable teams' names or moving message, dimensions 200x100 cm, radio transmission, including control panel



NOTE

Attenzione: I tabelloni elettronici della linea per esterno sono forniti completi di console di comando.

Attention: Outdoor line's electronic scoreboards are supplied complete of control panel.



**S05402**

Pallone minibasket in gomma-nylon,
misura 5
Rubber-nylon mini-basket ball, size 5

**S05404**

Pallone minibasket in gomma-nylon
Molten, misura 5
*Molten rubber-nylon mini-basket ball,
size 5*

**S05406**

Pallone basket femminile in
gomma-nylon, misura 6
Rubber-nylon female basket ball, size 6

**S05408**

Pallone basket femminile in pelle
sintetica da allenamento Molten,
misura 6
*Molten synthetic leather female basket
ball for training, size 6*

**S05410**

Pallone basket femminile in pelle
sintetica Molten omologato FIBA,
misura 6
*Molten synthetic leather female basket
ball FIBA approved, size 6*

**S05412**

Pallone basket in gomma-nylon,
misura 7
Rubber-nylon basket ball, size 7

**S05414**

Pallone basket in gomma-nylon Molten,
misura 7
*Molten rubber-nylon basket ball,
size 7*

**S05416**

Pallone basket in pelle sintetica da
allenamento, misura 7
*Synthetic leather basket ball for training,
size 7*

**S05418**

Pallone basket in pelle sintetica da
allenamento Molten, misura 7
*Molten synthetic leather basket ball for
training, size 7*

**S05420**

Pallone basket in pelle sintetica Molten
omologato FIBA, misura 7
*Molten synthetic leather basket ball FIBA
approved, size 7*

**S05452**

Pallone calcetto in gomma-nylon,
misura 4

Rubber-nylon futsal ball, size 4

**S05454**

Pallone calcetto indoor in feltro cucito,
misura 4

Felt futsal ball for indoor use, size 4

**S05456**

Pallone calcetto in pelle sintetica da
allenamento, misura 4

Synthetic leather futsal ball, size 4

**S05458**

Pallone calcetto in pelle sintetica a
rimbalzo ridotto da gara, misura 4

*Synthetic leather futsal ball for
competition, reduced rebound, size 4*

**S05460**

Pallone calcetto in pelle sintetica Select
da gara, misura 4

*Select synthetic leather futsal ball for
competition, size 4*

**S05462**

Pallone calcio in gommapiuma diametro
cm 20

Foam soccer ball diameter 20 cm

**S05464**

Pallone calcio in gomma-nylon, misura 5

Rubber-nylon soccer ball, size 5

**S05466**

Pallone calcio in pelle sintetica da
allenamento, misura 5

*Synthetic leather soccer ball for training,
size 5*

**S05468**

Pallone calcio in pelle sintetica Select
omologato FIFA, misura 5

*Select synthetic leather soccer ball FIFA
approved, size 5*

**S05470**

Pallone con gancio per forza palloni in
pelle sintetica

*Synthetic leather soccer ball with hook
for header practice stand*

NOTE

Scarica il Catalogo aggiornato di Sport System dal sito
www.sportssystem.it

Download the last edition of Sport System's Catalogue at
www.sportssystem.it

36

Palloni pallamano - Handball balls

160 / 210

**S05502**

Pallone pallamano maschile in gomma-nylon, misura 3
Rubber-nylon male handball, size 3

**S05504**

Pallone pallamano maschile in pelle sintetica da allenamento, misura 3
Synthetic leather male handball for training, size 3

**S05506**

Pallone pallamano maschile in pelle sintetica Select omologato IHF, misura 3
Select synthetic leather male handball IHF approved, size 3

**S05508**

Pallone pallamano femminile in gomma-nylon, misura 2
Rubber-nylon female handball, size 2

**S05510**

Pallone pallamano femminile in pelle sintetica da allenamento, misura 2
Synthetic leather female handball for training, size 2

**S05512**

Pallone pallamano femminile in pelle sintetica Select omologato IHF, misura 2
Select synthetic leather female handball IHF approved, size 2

37

Palloni volley e minivolley - Volley and minivolley balls

**S05552**

Pallone minivolley ufficiale FIPAV
Official FIPAV minivolley ball

**S05554**

Pallone super minivolley
Super minivolley ball

**S05556**

Pallone pallavolo in gomma-nylon bicolore, misura 5
Rubber-nylon volley ball two colours, size 5

**S05558**

Pallone pallavolo in pelle sintetica da allenamento, misura 5
Synthetic leather volley ball for training, size 5

**S05560**

Pallone pallavolo in pelle sintetica da allenamento Mikasa, misura 5
Mikasa synthetic leather volley ball for training, size 5

**S05562**

Pallone pallavolo in pelle sintetica da allenamento Molten, misura 5
Molten synthetic leather volley ball for training, size 5

**S05564**

Pallone pallavolo in pelle sintetica
Mikasa omologato FIVB, misura 5
*Mikasa synthetic leather volley ball FIVB
approved, size 5*

**S05566**

Pallone pallavolo in pelle sintetica
Molten omologato FIVB, misura 5
*Molten synthetic leather volley ball FIVB
approved, size 5*

38

Palloni per sport da spiaggia, rugby e pallanuoto

Balls for beach sports, rugby and waterpolo

**S05602**

Pallone beach handball super soft
Super soft beach handball ball

**S05604**

Pallone beach soccer in pelle sintetica
super soft
*Super soft synthetic leather beach soccer
ball*

**S05606**

Pallone beach volley in pelle sintetica
super soft
*Super soft synthetic leather beach volley
ball*

**S05608**

Pallone rugby in pelle sintetica
Synthetic leather rugby ball

**S05610**

Pallone pallanuoto maschile in
gomma-nylon
Rubber-nylon water polo ball for male

**S05612**

Pallone pallanuoto femminile in
gomma-nylon
Rubber-nylon water polo ball for female

39

Cesti porta palloni, accessori di gonfiaggio

Balls trolleys, inflating accessories

**S05652**

Gabbia porta palloni in acciaio verniciato mobile su ruote

Varnished steel ball carrier mobile on wheels

**S05654**

Gabbia porta palloni in acciaio zincato mobile su ruote

Galvanized steel ball carrier mobile on wheels

**S05656**

Carrello porta palloni pieghevole, struttura in acciaio verniciato, sacco in nylon

Foldable ball transporter, varnished steel structure, nylon basket

**S05658**

Carrello espositore per palloni in acciaio verniciato mobile su ruote

Varnished steel wheelaway ball rack

**S05660**

Pompa a staffa per gonfiaggio palloni

Hand pump inflating balls

**S05662**

Pompa a staffa con serbatoio per gonfiaggio palloni

Hand pump with tank inflating balls

**S05664**

Compressore elettrico per gonfiaggio palloni

Electric ball compressor inflating balls

**S05666**

Rete porta palloni in nylon

Nylon net carrying balls

**S05702**

Coppia parastinchi professionali con paramalleoli
Pair of soccer players' shinguards

**S05704**

Paio guanti portiere con palmo di gomma
Pair of soccer goalkeeper gloves

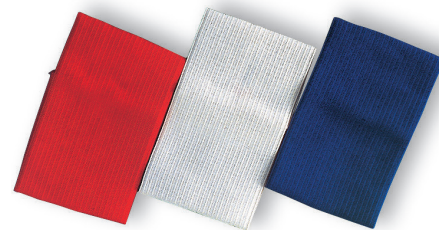
**S05706**

Fascia da capitano in tessuto elastico con Velcro
Elastic arm belts for captain

**S05708**

Fischietto Fox 40 ufficiale per arbitro
Fox 40 official whistle for referee

**S05710**

Paio ginocchiere volley con foro posteriore
Pair of volleyball players' knee protectors

**S05714**

Nastro taping per protezione dita giocatori pallavolo, in rotolo da mt 25
Taping band for protecting volleyball players' fingers, 25 mt long

**S05718**

Completo maschile calcio, pallamano o pallavolo composto di maglia a manica corta e pantaloni, eventualmente personalizzabile con numeri o serigrafie varie

Male uniform suitable for soccer, handball and volleyball composed of t-shirt and pants, eventually customizable with numbers or logos

**S05720**

Completo femminile pallavolo composto di canotta e pantaloni, eventualmente personalizzabile con numeri o serigrafie varie

Female uniform suitable for volleyball composed of vest and pants, eventually customizable with numbers or logos

Reversible
Reversible**S05722**

Completo maschile e femminile basket reversibile composto di canotta e pantaloni bi-colore, eventualmente personalizzabile con numeri o serigrafie varie

Female and male double-face uniform suitable for basketball composed of vest and pants in 2 colors, eventually customizable with numbers or logos

NOTE

I completi S05718, S05720, S05722 possono essere personalizzati con numeri o serigrafia.

Uniforms S05718, S05720, S05722 can be customized with numbers or logos, on demand.

**S05724**

Borsa sportiva in tessuto poliestere, con vano portascarpe
Sporting bag made in polyester with shoes shelter

**S05725**

Borsa in tessuto porta medicinali, con tasche esterne
Polyester medicine bag with outside pockets

**S05726**

Ghiaccio chimico istantaneo in busta
Instant cold compress, ice pack

**S05728**

Ghiaccio spray in bomboletta da ml 400
Cooling spray in can of 400 ml



ARREDI

Nella categoria Arredi è presentata la linea di arredi ed accessori per il completamento funzionale dei **campi di gioco indoor e outdoor** e per **l'allestimento dei locali annessi alle aree di gioco**, disegnati e prodotti con attenzione particolare alla qualità dei materiali utilizzati e delle finiture proposte e con attenzione alla **possibilità di personalizzare le soluzioni standard** secondo le esigenze del cliente, sia dal punto di vista estetico che pratico.



FURNITURE

*A complete range of **furnishing and accessories** enabling customers to entirely equip any sport venue (from the spectators' area to changing room, from infirmaries to meeting and press rooms ...). All products designed and manufactured with priority given to using best quality materials, level of fittings and **the option of customizing each single product**, both from an aesthetic and functional point of view and based on customer's demand.*

**S07002**

Armadio porta attrezzi di lamiera verniciata ad ante battenti con vano interno porta valori, dimensioni cm 100X45X200

Equipment locker made from varnished sheet steel with shelves and lockable compartment for valuables inside, dimensions 100x45x200 cm

**S07004**

Armadio porta attrezzi di lamiera verniciata ad ante battenti con 4 ripiani, dimensioni cm 100x45x200

Equipment locker made from varnished sheet steel with 4 shelves inside, dimensions 100x45x200 cm

**S07006**

Armadio porta attrezzi di lamiera verniciata ad ante scorrevoli con 4 ripiani, dimensioni cm 120x45x200

Equipment locker made from varnished sheet steel with 4 shelves inside and sliding doors, dimensions 120x45x200 cm

**S07008**

Armadio porta attrezzi con pareti in rete metallica zincata e 2 ripiani, dimensioni cm 155x75x160 mobile su ruote, smontabile

Equipment trolley mobile on wheels, made of galvanized steel mesh walls with 2 shelves, dimensions 155x75x160 cm, can be dismantled

**S07010**

Scaffalatura in lamiera a 5 ripiani, dimensioni cm 100x40x200

Steel shelter with 5 shelves, dimensions 100x40x200 cm

**S07102**

Armadio con anta a battente, 4 ripiani, pareti in vetro temperato e chiusura a chiave

Infirmery locker with 1 door, 4 shelves, tempered glass walls

**S07104**

Armadio con 2 ante a battente, 4 ripiani, pareti in vetro temperato e chiusura a chiave

Infirmery locker with 2 doors, 4 shelves, tempered glass walls

**S07106**

Paravento a 3 ante con struttura pieghevole di acciaio cromato

Three shutter screen with foldable chromed steel structure

**S07108**

Appendiabiti a colonna di acciaio verniciato e plastica

Varnished steel and plastic clothes stand

**S07110**

Scrivania a 3 cassetti con chiusura a chiave, struttura di metallo verniciato e piano di nobilitato bilaminato

Desk with 3 drawers key secured, made of varnished steel structure and chipboard surface

**S07112**

Poltroncina imbottita con struttura metallica cromata e braccioli, ignifuga
Padded fireproof armchair with chromed steel structure

**S07114**

Sedia imbottita con struttura metallica cromata, ignifuga
Padded fireproof chair with chromed steel structure

S07116 + S07118 + S07120

**S07116**

Lettino visita medica con testiera reclinabile, struttura di acciaio cromato e verniciato, piani imbottiti e rivestiti
Medical examination couch with reclining headrest, chromed and varnished steel structure, padded and coated surfaces

**S07117**

Lettino visita medica con testiera reclinabile, struttura di acciaio cromato e verniciato, piani imbottiti e rivestiti, completo di foro per respirazione e tappo
Medical examination couch with reclining headrest, chromed and varnished steel structure, padded and coated surfaces, complete with breathing hole and bung

S07122

**S07118**

Porta rotolo in acciaio cromato per lettino visita medica
Paper roll holder for examination couch made of chromed steel

**S07120**

Rotolo di carta per lettino visita medica
Roll of paper for examination couch

S07122

Lettino visita medica e massaggi pieghevole e trasportabile, struttura in metallo, piani imbottiti e rivestiti
Foldable and transportable examination and massage couch, metal structure, padded and coated surfaces

**S07123**

Letto massaggi a due segmenti imbottiti e rivestiti in similpelle, regolabili elettricamente in altezza ed inclinazione, testiera con foro per respirazione, struttura in acciaio verniciato
Medical examination couch made of two padded and vinyl covered sections electrically adjustable in height and inclination, headpiece with breathing hole, varnished steel structure

**S07124**

Sgabello girevole di alluminio
Turnable stool made of aluminium

**S07126**

Sgabello girevole di acciaio verniciato con sedile imbottito
Turnable stool with varnished steel structure and padded seat

**S07128**

Scaletta scendiletto a 2 gradini con struttura in acciaio cromato
Chromed steel bedside step ladder with 2 steps

**S07130**

Porta rifiuti in metallo con coperchio azionabile a pedale
Metal pedal trashcan

**S07132**

Porta rifiuti di plastica colorata
Coloured plastic trashcan

**S07134**

Portantina porta feriti pieghevole con struttura di acciaio cromato
Foldable stretcher with chromed steel frame

**S07136**

Cassetta medica portatile applicabile a parete con kit accessori secondo d.m. 388

Portable first aid kit box to be fixed to the wall including set of first aid accessories

**S07138**

Cassetta medica da fissare a parete con kit accessori secondo d.m. 388

Wall mounted first aid kit cabinet including set of first aid accessories

**S07140**

Autorespiratore AMBU in valigetta di ABS contenente mascherina, apribocca, tiralingua

AMBU life-support system with accessories, in plastic case

**S07142**

Sfigmomanometro senza mercurio da tavolo con display LCD, completo di fonendoscopio

Tabletop use sphygmomanometer mercury-free with LCD display, complete of stethoscope

**S07146**

Carrello porta strumenti mobile su ruote, struttura con maniglie in alluminio, ripiani in bilaminato con sponde, dimensioni cm 60x40x80

Medical trolley with aluminium structure and handles, mobile on wheels, white laminated shelves with guard-rail, dimensions 60x40x80 cm

**S07148**

Bilancia pesa persone con statimetro

Scales for persons with height measurer

**S07150**

Defibrillatore semiautomatico esterno (DAE) portatile su valigetta, completo di istruzioni

Semi-automatic external defibrillator (AED) portable on case, complete of instructions

NOTE

Con il Decreto del Consiglio dei Ministri n.44 del 5/9/2012 è fatto obbligo a tutte le società sportive di dotarsi di un defibrillatore semiautomatico esterno (DAE), per maggiori informazioni scrivere a info@sportssystem.it

In Italy it is now mandatory for each sport club to have an AED device available in proper facility.

**S07202**

Armadio spogliatoio a 1 posto di lamiera verniciata, dimensioni cm 37x35x180

Varnished sheet steel wardrobe at 1 door, dimensions 37x35x180 cm

**S07206**

Armadio spogliatoio a 2 posti di lamiera verniciata, dimensioni cm 70x35x180

Varnished sheet steel wardrobe at 2 doors, dimensions 70x35x180 cm

**S07208**

Armadio spogliatoio a 2 posti di lamiera verniciata con ante colorate, dimensioni cm 70x35x180

Varnished sheet steel wardrobe at 2 coloured doors, dimensions 70x35x180 cm

S07204

Armadio spogliatoio a 1 posto di lamiera verniciata con anta colorata, dimensioni cm 37x35x180

Varnished sheet steel wardrobe at 1 coloured door, dimensions 37x35x180 cm

**S07210****S07210**

Armadio spogliatoio a 3 posti di lamiera verniciata, dimensioni cm 103x35x180

Varnished sheet steel wardrobe at 3 doors, dimensions 103x35x180 cm

**S07214**

Armadio spogliatoio a 4 posti (2+2) di lamiera verniciata, dimensioni cm 70x35x180

Varnished sheet steel wardrobe at 4 doors (2+2), dimensions 70x35x180 cm

S07212

Armadio spogliatoio a 3 posti di lamiera verniciata con ante colorate, dimensioni cm 103x35x180

Varnished sheet steel wardrobe at 3 coloured doors, dimensions 103x35x180 cm

**S07216**

Armadio spogliatoio a 4 posti (2+2) di lamiera verniciata con ante colorate, dimensioni cm 70x35x180

Varnished sheet steel wardrobe at 4 coloured doors (2+2), dimensions 70x35x180 cm

**S07218**

Armadio spogliatoio a 6 posti (3+3) di lamiera verniciata, dimensioni cm 103x35x180

Varnished sheet steel wardrobe at 6 doors (3+3), dimensions 103x35x180 cm

**S07222**

Armadio casellario a 10 posti (2x5h) di lamiera verniciata, dimensioni cm 70x35x180

Varnished sheet steel small compartments locker with 10 doors (2x5h), dimensions 70x35x180 cm

**S07220**

Armadio spogliatoio a 6 posti (3+3) di lamiera verniciata con ante colorate, dimensioni cm 103x35x180

Varnished sheet steel wardrobe at 6 coloured doors (3+3), dimensions 103x35x180 cm

S07224

Armadio casellario a 10 posti (2x5h) di lamiera verniciata con ante colorate, dimensioni cm 70x35x180

Varnished sheet steel small compartments locker with 10 coloured doors (2x5h), dimensions 70x35x180 cm

S07226

Armadio casellario a 15 posti (3x5h) di lamiera verniciata, dimensioni cm 103x35x180

Varnished sheet steel small compartments locker with 15 doors (3x5h), dimensions 103x35x180 cm

S07228

Armadio casellario a 15 posti (3x5h) di lamiera verniciata con ante colorate, dimensioni cm 103x35x180

Varnished sheet steel small compartments locker with 15 coloured doors (3x5h), dimensions 103x35x180 cm

S07226



**S07252**

Armadio spogliatoio in laminato stratificato con giunti di nylon e piedini di acciaio regolabili. Colonna con due vani aventi dimensioni cm 30x50x90

Locker made of hpl panels with nylon joints, steel adjustable feet. Column with two compartments having dimensions 30x50x90 cm

S07254

Armadio spogliatoio in laminato stratificato con giunti di nylon e piedini di acciaio regolabili. Nr 2 colonne con due vani aventi dimensioni cm 30x50x90

Locker made of hpl panels with nylon joints, steel adjustable feet. Nr 2 columns with two compartments having dimensions 30x50x90 cm

S07256

Armadio spogliatoio in laminato stratificato con giunti di nylon e piedini di acciaio regolabili. Nr 3 colonne con due vani aventi dimensioni cm 30x50x90

Locker made of hpl panels with nylon joints, steel adjustable feet. Nr 3 columns with two compartments having dimensions 30x50x90 cm

S07258

Armadio spogliatoio in laminato stratificato con giunti di nylon e piedini di acciaio regolabili. Colonna con singolo vano avente dimensioni cm 30x50x180

Locker made of hpl panels with nylon joints, steel adjustable feet. Column with single compartment having dimensions 30x50x180 cm

S07260

Armadio spogliatoio in laminato stratificato con giunti di nylon e piedini di acciaio regolabili. Nr 2 colonne con singolo vano avente dimensioni cm 30x50x180

Locker made of hpl panels with nylon joints, steel adjustable feet. Nr 2 columns with single compartment having dimensions 30x50x180 cm

S07262

Armadio spogliatoio in laminato stratificato con giunti di nylon e piedini di acciaio regolabili. Nr 3 colonne con singolo vano avente dimensioni cm 30x50x180

Locker made of hpl panels with nylon joints, steel adjustable feet. Nr 3 columns with single compartment having dimensions 30x50x180 cm

**S07264**

Armadio spogliatoio in laminato stratificato su profili in alluminio e piedini regolabili. Colonna con due vani aventi dimensioni cm 30x50x90

Locker made of hpl panels mounted on aluminium profiles, steel adjustable feet. Column with two compartments having dimensions 30x50x90 cm

S07266

Armadio spogliatoio in laminato stratificato su profili in alluminio e piedini regolabili. Nr 2 colonne con due vani aventi dimensioni cm 30x50x90

Locker made of hpl panels mounted on aluminium profiles, steel adjustable feet. Nr 2 columns with two compartments having dimensions 30x50x90 cm

S07268

Armadio spogliatoio in laminato stratificato su profili in alluminio e piedini regolabili. Nr 3 colonne con due vani aventi dimensioni cm 30x50x90

Locker made of hpl panels mounted on aluminium profiles, steel adjustable feet. Nr 3 columns with two compartments having dimensions 30x50x90 cm

S07270

Armadio spogliatoio in laminato stratificato su profili in alluminio e piedini regolabili. Colonna con singolo vano avente dimensioni cm 30x50x180

Locker made of hpl panels mounted on aluminium profiles, steel adjustable feet. Column with single compartment having dimensions 30x50x180 cm

S07272

Armadio spogliatoio in laminato stratificato su profili in alluminio e piedini regolabili. Nr 2 colonne con singolo vano avente dimensioni cm 30x50x180

Locker made of hpl panels mounted on aluminium profiles, steel adjustable feet. Nr 2 columns with single compartment having dimensions 30x50x180 cm

S07274

Armadio spogliatoio in laminato stratificato su profili in alluminio e piedini regolabili. Nr 3 colonne con singolo vano avente dimensioni cm 30x50x180

Locker made of hpl panels mounted on aluminium profiles, steel adjustable feet. Nr 3 columns with single compartment having dimensions 30x50x180 cm

S07275

Modulo spogliatoio individuale interamente realizzato con pannelli di nobilitato melaminico con seduta e schienale imbottiti e rivestiti in ecopelle. Personalizzabile nella composizione e nelle dimensioni di vani a giorno e vani chiusi, nella scelta dei colori e con ricamo testo o logo su schienale. Dimensioni indicative cm 70x90x210h

Locker room individual module entirely made of coloured melamine panels with seating element and backrest padded and synthetic leather covered. To be customized on composition and size of open and closed cells, on colours selection and by embroidering text or logo on backrest. Indicative dimensions cm 70x90x210h

**S07276**

Modulo spogliatoio individuale VIP composto di cabina principale sagomata con asta appendiabiti e mensole, colonna armadio con ripiani e porta chiudibile a chiave, il tutto realizzato in laminato stratificato colorato, compresa poltrona in pelle sintetica incassata nella cabina principale. Soluzione completamente personalizzabile nelle dimensioni, nella finitura, nella combinazione cromatica oltre che nella scelta del modello di poltrona

VIP locker room individual module composed of main cabin with shelves and clothes hanger rail, side column with shelves and lockable door, all the above made in colored hpl, including synthetic leather covered armchair to be installed inside main cabin. Solution to be totally customized on dimensions, finishing, chromatic combinations over than the choice of armchair model

**NOTE**

LA GIUSTA SOLUZIONE PER QUALSIASI ESIGENZA! - THE RIGHT CHOICE FOR ANY DEMAND!

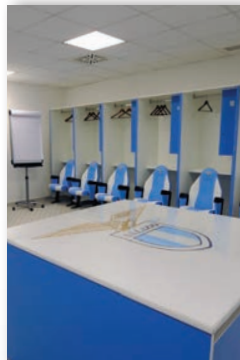

S07301

**S07301**

Panchina spogliatoio semplice, struttura di acciaio verniciato e listoni di legno, lunghezza mt 1

Locker room bench, varnished steel structure and wooden planks, length 1 mt

S07302

Panchina spogliatoio semplice, struttura in acciaio verniciato e listoni di legno, lunghezza mt 1,5

Locker room bench, varnished steel structure and wooden planks, length 1.5 mt

S07303

**S07303**

Panchina spogliatoio semplice, struttura di acciaio verniciato e listoni di legno, lunghezza mt 2

Locker room bench, varnished steel structure and wooden planks, length 2 mt

S07304

Panchina spogliatoio con schienale, struttura di acciaio verniciato e listoni di legno, lunghezza mt 1

Locker room bench with backrest, varnished steel structure and wooden planks, length 1 mt

S07305

Panchina spogliatoio con schienale, struttura di acciaio verniciato e listoni di legno, lunghezza mt 1,5

Locker room bench with backrest, varnished steel structure and wooden planks, length 1.5 mt

S07306

**S07306**

Panchina spogliatoio con schienale, struttura di acciaio verniciato e listoni di legno, lunghezza mt 2

Locker room bench with backrest, varnished steel structure and wooden planks, length 2 mt

S07307

Panchina spogliatoio con schienale e doga appendiabiti, struttura di acciaio verniciato e listoni di legno, lunghezza mt 1

Locker room bench with backrest and wooden clothes hanger rail, varnished steel structure and wooden planks, length 1 mt

S07308

Panchina spogliatoio con schienale e doga appendiabiti, struttura di acciaio verniciato e listoni di legno, lunghezza mt 1,5

Locker room bench with backrest and wooden clothes hanger rail, varnished steel structure and wooden planks, length 1.5 mt



S07304

Panchine testate secondo la norma EN 16139.

NOTE

Locked room benches tested accordingly to EN 16139 standard.

**S07309**

Panchina spogliatoio con schienale e doga appendiabiti, struttura di acciaio verniciato e listoni di legno, lunghezza mt 2

Locker room bench with backrest and wooden clothes hanger rail, varnished steel structure and wooden planks, length 2 mt

S07311

Panchina spogliatoio completa, struttura di acciaio verniciato e listoni di legno, lunghezza mt 1,5

Complete locker room bench, varnished steel structure and wooden planks, length 1.5 mt



S07312

S07312

Panchina spogliatoio completa, struttura di acciaio verniciato e listoni di legno, lunghezza mt 2

Complete locker room bench, varnished steel structure and wooden planks, length 2 mt

S07310

**S07310**

Panchina spogliatoio completa, struttura di acciaio verniciato e listoni di legno, lunghezza mt 1

Complete locker room bench, varnished steel structure and wooden planks, length 1 mt

S07313

Panchina spogliatoio completa ad isola per posizionamento a centro locale, struttura di acciaio verniciato e listoni di legno, lunghezza mt 1

Double side complete locker room bench, varnished steel structure and wooden planks, length 1 mt

S07314

Panchina spogliatoio completa ad isola per posizionamento a centro locale, struttura di acciaio verniciato e listoni di legno, lunghezza mt 1,5

Double side complete locker room bench, varnished steel structure and wooden planks, length 1.5 mt

**S07315**

Panchina spogliatoio completa ad isola per posizionamento a centro locale, struttura di acciaio verniciato e listoni di legno, lunghezza mt 2

Double side complete locker room bench, varnished steel structure and wooden planks, length 2 mt



S07318

**S07318**

Panca per disabili, struttura di acciaio, piano ribaltabile di cm 100x60 e doppio piano porta oggetti

Bench for disabled people, varnished steel structure, reclining seating area 100x60 cm with double shelves

**S07320**

Attaccapanni con porta borse da fissare a parete, struttura di acciaio verniciato e listoni di legno, lunghezza mt 2 con 6 grucce di nylon

Clothes hanger rail with bags support to be fixed to the wall, varnished steel structure and wooden planks, length 2 mt with 6 nylon hangers

S07321

Attaccapanni con porta borse da fissare a parete, struttura di acciaio verniciato e listoni di legno, lunghezza mt 1,5 con 4 grucce

Clothes hange rail with bags support to be fixed to the wall, varnished steel structure and wooden planks, length 1.5 mt with 4 nylon hangers

S07322

Attaccapanni con porta borse da fissare a parete, struttura di acciaio verniciato e listoni di legno, lunghezza mt 1 con 3 grucce di nylon

Clothes hanger rail with bags support to be fixed to the wall, varnished steel structure and wooden planks, length 1 mt with 3 nylon hangers

**S07324**

Tavola attaccapanni di legno da fissare a parete, lunghezza mt 2 con 6 grucce di nylon

Wooden clothes hanger rail to be fixed to the wall, length 2 mt with 6 nylon hangers

S07325

Tavola attaccapanni di legno da fissare a parete, lunghezza mt 1,5 con 4 grucce

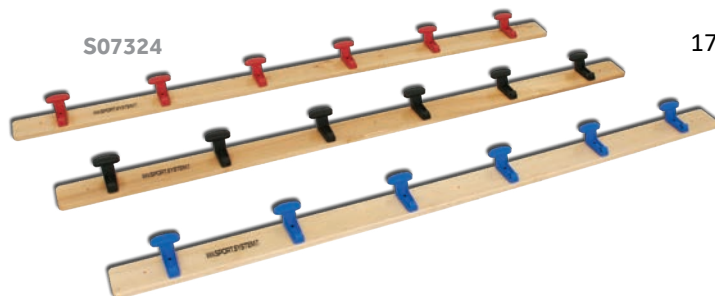
Wooden clothes hanger rail to be fixed to the wall, length 1.5 mt with 4 nylon hangers

S07326

Tavola attaccapanni di legno da fissare a parete, lunghezza mt 1 con 3 grucce di nylon

Wooden clothes hanger rail to be fixed to the wall, length 1 mt with 3 nylon hangers

7

Panchine spogliatoio con struttura di alluminio - Aluminium structure benches



S07352

S07352

Panchina spogliatoio semplice, struttura di alluminio anodizzato, lunghezza mt 2

Locker room bench, aluminium structure, length 2 mt

S07354

Panchina spogliatoio semplice, struttura di alluminio anodizzato, lunghezza mt 1

Locker room bench, aluminium structure, length 1 mt



S07356

S07356

Panchina spogliatoio con schienale, struttura di alluminio anodizzato, lunghezza mt 2

Locker room bench with backrest, aluminium structure, length 2 mt

S07358

Panchina spogliatoio con schienale, struttura di alluminio anodizzato, lunghezza mt 1

Locker room bench with backrest, aluminium structure, length 1 mt



S07360

S07360

Panchina spogliatoio completa, struttura di alluminio anodizzato, lunghezza mt 2
Complete locker room bench, aluminium structure, length 2 mt

S07362

Panchina spogliatoio completa, struttura di alluminio anodizzato, lunghezza mt 1
Complete locker room bench, aluminium structure, length 1 mt

S07364

Panchina per spogliatoio completa, ad isola, per posizionamento a centro locale, struttura di alluminio anodizzato, lunghezza mt 2
Double side complete locker room bench, aluminium structure, length 2 mt

S07366

Panchina per spogliatoio completa, ad isola, per posizionamento a centro locale, struttura di alluminio anodizzato, lunghezza mt 1
Double side complete locker room bench, aluminium structure, length 1 mt

S07368

Attaccapanni con porta borse da fissare a parete, struttura di alluminio, lunghezza mt 2 con 6 grucce di plastica
Clothes hanger rail with bags support to be fixed to the wall, aluminium structure, length 2 mt with 6 plastic hangers

S07370

Attaccapanni con porta borse da fissare a parete, struttura di alluminio, lunghezza mt 1 con 3 grucce di plastica
Clothes hanger rail with bags support to be fixed to the wall, aluminium structure, length 1 mt with 3 plastic hangers

**S07372**

Tavola attaccapanni di alluminio da fissare a parete, lunghezza mt 2 con 6 grucce di plastica
Aluminium clothes hanger rail to be fixed to the wall, length 2 mt with 6 plastic hangers

S07374

Tavola attaccapanni di alluminio da fissare a parete, lunghezza mt 1 con 3 grucce di plastica
Aluminium clothes hanger rail to be fixed to the wall, length 1 mt with 3 plastic hangers

8

Accessori per spogliatoio Accessories for locker room

**S07404**

Pedana poggiapiedi di legno con piedini gommati, lunghezza mt 2
Wooden footrest with rubber feet, length 2 mt

**S07406**

Pedana poggiapiedi di legno con piedini gommati, lunghezza mt 1
Wooden footrest with rubber feet, length of 1 mt

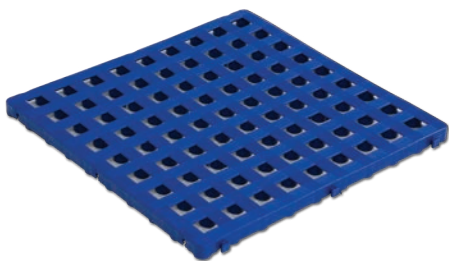

S07408

S07408

Modulo pedana poggiapiedi di plastica
agganciabile, dimensioni cm 50x50
*Attachable plastic footrest element,
dimensions 50x50 cm*



S07410

S07410

Tavolo per massaggi, struttura di acciaio verniciato, piano imbottito
e rivestito
Massage couch, varnished steel structure, padded and coated surface



S07412

S07412

Tavolo per spogliatoio, struttura di
acciaio verniciato, dimensioni cm
80x80x76
*Locker room table, varnished steel
structure, dimensions 80x80x76 cm*



S07414

S07414

Sedia di acciaio cromato con scocca di
polipropilene colorato
*Chromed steel chair with coloured
polypropylene seat*



S07416

S07416

Bacheca con struttura di alluminio
anodizzato, dimensioni cm 120x90
*Wall mounted notice board with
aluminium structure, dimensions 120x90
cm*



S07418

S07418

Porta ombrelli di acciaio verniciato
Varnished steel umbrella stand



S07420

S07420

Porta rifiuti di plastica colorata
Coloured plastic trashcan

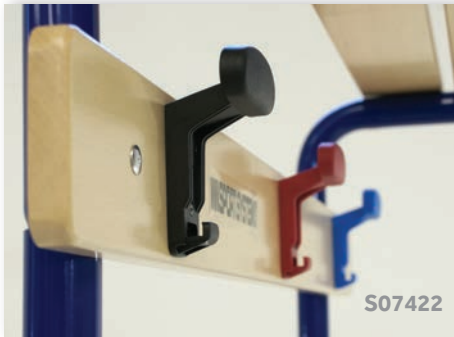

S07422

S07422

Appendiabiti di nylon colorato per tavola attaccapanni
Coloured nylon single clothes hanger for hanger plank



S07434

S07434

Graticcio per doccia di legno con piedini gommati, dimensioni cm 60x60
Wooden shower grid with rubber feet, dimensions 60x60 cm



S07440

S07440

Distributore di sapone liquido di acciaio da fissare a parete
Stainless steel liquid soap dispenser to be fixed to the wall



S07424

S07424

Appendiabiti singolo di plastica da fissare a parete
Plastic clothes hanger to be fixed to the wall



S07436

S07436

Porta saponetta di plastica da fissare a parete
Plastic soap support to be fixed to the wall

S07442

**S07442**

Distributore di salviette di plastica da fissare a parete
Plastic hand towel dispenser to be fixed to the wall

S07426

Appendiabiti singolo di acciaio da fissare a parete
Steel clothes hanger to be fixed to the wall



S07437

S07437

Porta saponetta di acciaio da fissare a parete
Stainless steel soap support to be fixed to the wall

S07428

Divisorio per doccia con supporto di acciaio inox e pannello di laminato
Shower partition in stainless steel complete with hpl wall

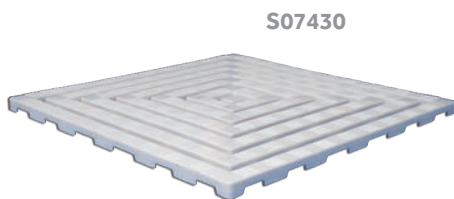

S07430

S07430

Graticcio per doccia di plastica, dimensioni cm 60x60
Plastic shower grid, dimensions 60x60 cm



S07438

S07438

Distributore di sapone liquido di plastica da fissare a parete
Plastic liquid soap dispenser to be fixed to the wall

NOTE

Le immagini degli accessori per spogliatoio dall'articolo **S07424** al **S07482** sono indicative.

*Images of locker room's accessories from article **S07424** to **S07482** are indicatives.*



S07444

S07444

Distributore di salviette di acciaio da fissare a parete
Stainless steel hand towel dispenser to be fixed to the wall



S07452

S07452

Specchio a parete basculante per disabili
Reclining wall mirror for disabled people

S07462

Asciugacapelli elettrico con temporizzatore, scocca di plastica
Hair dryer with plastic shell

S07464

**S07464**

Asciugacapelli elettrico con temporizzatore e tubo flessibile, scocca di alluminio
Hair dryer with aluminium shell, equipped with flexible tube

S07446

**S07446**

Confezione di salviette di carta
Package of paper hand towels

S07456

Mensola di vetro e metallo per specchio, lunghezza cm 60
Glass and steel shelf for mirror, length 60 cm

S07458

**S07458**

Asciugamani elettrico con temporizzatore, scocca di plastica
Hand dryer with plastic shell

S07466

**S07466**

Asciugacapelli elettrico con temporizzatore e tubo flessibile, scocca di plastica
Hair dryer with plastic shell, equipped with flexible tube



S07448

S07448

Specchio a parete con cornice, diametro cm 50
Wall mirror with plastic frame, diameter 50 cm

S07460

Asciugamani elettrico con temporizzatore, scocca di alluminio
Hand dryer with aluminium shell

S07468

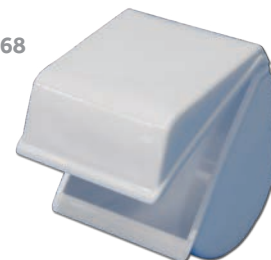
**S07468**

Porta rotolo carta igienica di plastica da fissare a parete
Plastic toilet paper roll holder to be fixed to the wall



S07462

S07470

**S07470**

Porta rotolo carta igienica di acciaio da fissare a parete

Stainless steel toilet paper roll holder to be fixed to the wall

S07472

**S07472**

Porta rotolo carta igienica maxi di plastica da fissare a parete

Maxi model plastic toilet paper roll holder to be fixed to the wall

S0747184 / 210

**S07474**

Porta rotolo carta igienica maxi di acciaio da fissare a parete

Maxi model stainless steel toilet paper roll holder to be fixed to the wall

S07476

**S07476**

Scopino per wc con porta scopino di plastica

Wc toilet brush cleaner with plastic support

S07478

**S07478**

Scopino per wc con porta scopino di acciaio

Wc toilet brush cleaner with stainless steel support

S07480

**S07480**

Porta sacchetti igienici femminili, di acciaio da fissare a parete

Female hygienic bags steel dispenser to be fixed to the wall

S07482

**S07482**

Cestino di plastica raccogli sacchetti igienici femminili

Female hygienic bags plastic trash can

9

Protezioni murali e bordo campo

Wall and boundary protections

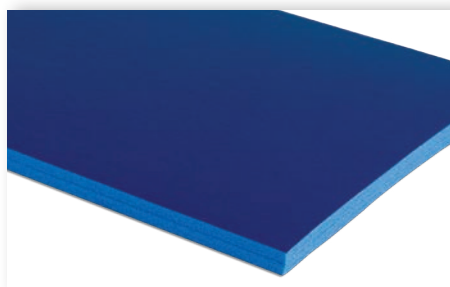
**S07502**

Protezione murale di polietilene ad alta densità, superficie di PVC, spessore mm 22, altezza cm 200, ignifuga e a norma EN913

Wall protection made of high density polyethylene covered with PVC, thickness 22 mm, height 200 cm, fireproof and EN913 tested

**S07503**

Protezione murale di polietilene con superficie in PVC per uso esterno, spessore mm 20, altezza cm 200, a norma EN913

Wall protection for outdoor use made of polyethylene covered with PVC, thickness 20 mm, height 200 cm, EN913 tested

**S07504**

Protezione per colonna di polietilene ad alta densità, superficie di PVC, spessore mm 22, altezza cm 200, ignifuga e a norma EN913

Column protection made of high density polyethylene covered with PVC, thickness 22 mm, height 200 cm, fireproof and EN913 tested

**S07505**

Protezione per colonna di polietilene con superficie in PVC per uso esterno, spessore mm 20, altezza cm 200, a norma EN913

Column protection for outdoor use made of polyethylene covered with PVC, thickness 20 mm, height 200 cm, EN913 tested

**S07506**

Protezione murale di gomma espansa completamente rivestita di PVC, banda occhiellata o Velcro per fissaggio, spessore mm 40

Wall protection made of high density foam fully covered with PVC, upper strip with steel rings or Velcro for easy fixing to the wall, thickness 40 mm

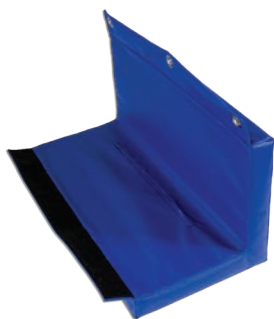
**S07508**

Protezione per colonna di gomma espansa rivestita di PVC, banda occhiellata o Velcro per fissaggio, spessore mm 40

Column protection made of high density foam covered with PVC, upper strip with steel rings or Velcro for easy fixing to the wall, thickness 40 mm

**S07510**

Protezione ONDA per parete e colonne in Polymat ignifugo e a norma EN913 per uso interno ed esterno, dimensioni cm 200x100

ONDA model wall and column protection made in fireproof and EN913 tested Polymat for indoor and outdoor use, dimensions 200x100 cm

**S07511**

Protezione paraspigoli in polietilene espanso ignifugo, spessore mm 10, larghezza cm 5+5, altezza cm 200

Corners protection made of fireproof polyethylene foam, thickness 10 mm, element of 5+5 cm, height 200 cm

**S07514**

Protezione paraspigoli per esterno in granuli di gomma EPDM, spessore mm 25, larghezza cm 10+10, lunghezza cm 98

Outdoor corners protection made of rubber granules EPDM, thickness 25 mm, element of 10+10 cm, length 98 cm

**S07516**

Protezione paraspigoli per esterno in gomma espansa spessore mm 25 con superficie in erba sintetica, larghezza cm 10+10, lunghezza cm 100

Outdoor corners protection made of foam thickness 25 mm covered artificial grass, element of 10+10 cm, length 100 cm

S07517

Colla per applicazione di protezioni murali e paraspigoli, in barattolo

Glue specific for application of wall and corners protection, supplied in can

**S07518**

Elementi di separazione e protezione bordo campo in gomma espansa rivestita di PVC ignifugo, sezione triangolare, base cm 200x50, altezza cm 75
Boundary protective pad for play court made of high density foam fully covered with fireproof PVC, triangular section with base 200x50 cm and height 75 cm



esempio di utilizzo S07518 - example of use for S07518

NOTE

Elementi di separazione **S07518** personalizzabili nel colore del PVC e nelle dimensioni, a richiesta; utili per supportare banner promozionali facilmente applicabili con Velcro o uso di bandella occhiellata.

*Boundary protective pad **S07518** can be customized on PVC's color and dimensions, on demand; useful for supporting promotional banner easily applicable by means of Velcro or eyelet belt.*

10

Reti divisorie e di protezione - *Dividing and boundary nets*

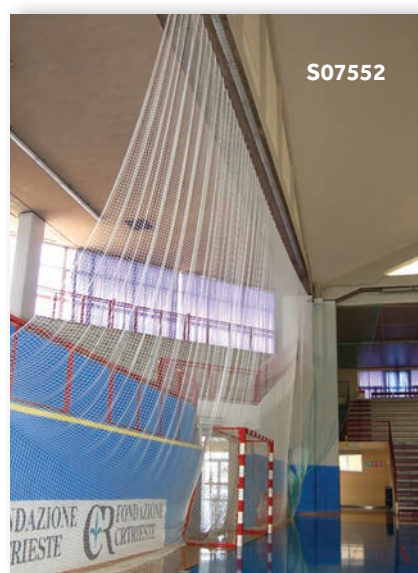

S07552

S07552

Rete divisoria e di protezione per uso interno in nylon ignifugo, diametro mm 3, maglia cm 10x10
Protective and dividing net made of fireproof nylon, diameter 3 mm, mesh 10x10 cm



S07554

S07554

Rete divisoria e di protezione per uso interno in nylon ignifugo, diametro mm 3, maglia cm 4,2x4,2
Protective and dividing net made of fireproof nylon, diameter 3 mm, mesh 4.2x4.2 cm



**S07556**

Bordatura perimetrale per rete
divisoria e di protezione
*Bording cord for protective and
dividing net*

**S07558**

Cavo in acciaio per sostegno rete
divisoria e di protezione
*Steel wire supporting protective and
dividing net*

**S07560**

Tenditore per cavo in acciaio
*Steel tensioner for wire supporting protective
and dividing net*

**S07562**

Anello in acciaio per
scorrimento rete su cavo
Steel fixing hook for net

11

Tende e pannelli divisori - Dividing curtains and panels

REFERENZE

REFERENCES

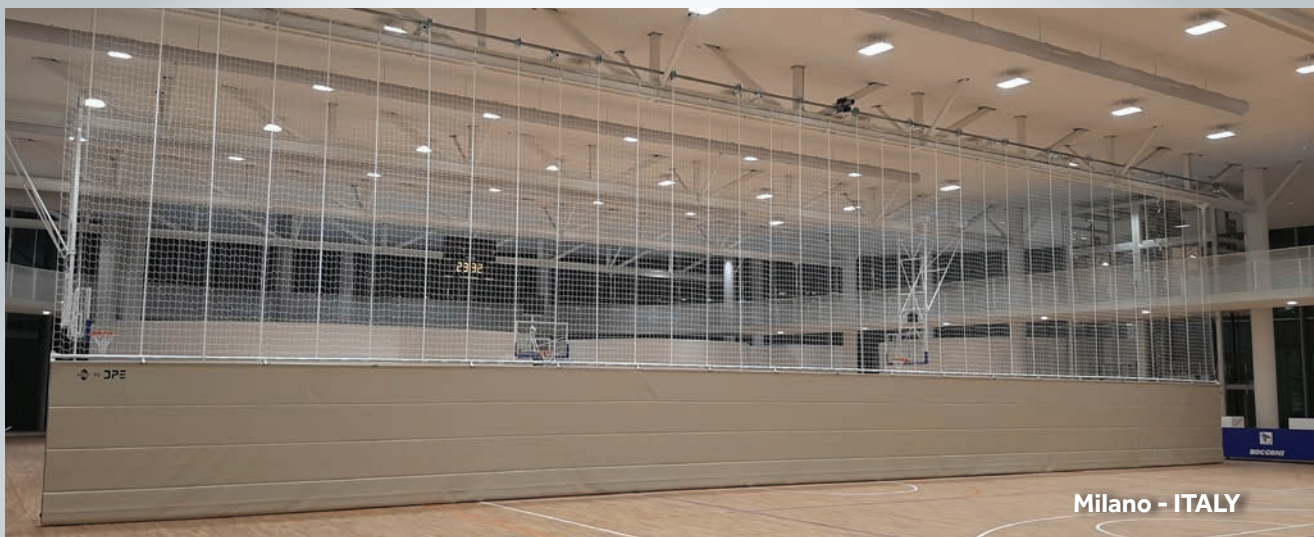

Milano - ITALY



Gorizia - ITALY

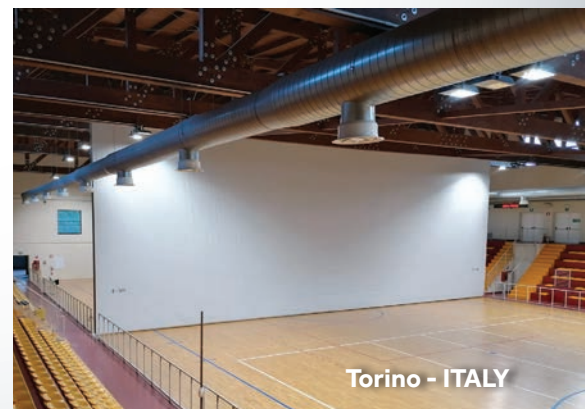

Torino - ITALY



S07601

Tenda divisoria combinata roll-up per campi gioco realizzata in materiale sintetico ignifugo a singolo telo per cm 270 da terra e "mesh" per la restante altezza, funzionamento elettrico. Chiusura compatta in soli 40 cm

Play-courts combined dividing roll-up curtain made of synthetic fireproof PVC, single layer, for 270 cm on bottom part and mesh on upper side, closing to the ceiling by electric motor. Compact closure in just 40 cm

**S07602**

Tenda divisoria "acustica" per campi da gioco realizzata in materiale sintetico ignifugo a doppio telo, scorrimento verticale con funzionamento elettrico

Play-courts "acoustic" dividing curtain made of synthetic fireproof PVC, double layer, closing to the ceiling by electric motor

**S07603**

Tenda divisoria combinata per campi gioco realizzata in materiale sintetico ignifugo a singolo telo per cm 270 da terra e rete a maglia cm 10x10 per la restante altezza, scorrimento verticale con funzionamento elettrico

Play-courts combined dividing curtain made of synthetic fireproof PVC, single layer, for 270 cm on bottom part and 10x10 cm net on upper side, closing to the ceiling by electric motor

**S07604**

Tenda divisoria combinata per campi gioco realizzata in materiale sintetico ignifugo a doppio telo per cm 220 da terra e rete a maglia cm 10x10 per la restante altezza, scorrimento verticale con funzionamento elettrico

Play-courts combined dividing curtain made of synthetic fireproof PVC, double layer, for 220 cm on bottom part and 10x10 cm net on upper side, closing to the ceiling by electric motor



S07606

Rete divisoria e di protezione per campi gioco a maglia cm 10x10 per tutta l'altezza, scorrimento verticale con funzionamento elettrico

Play-courts dividing and protective netting, mesh 10x10 cm, for the whole height, closing to the ceiling by electric motor

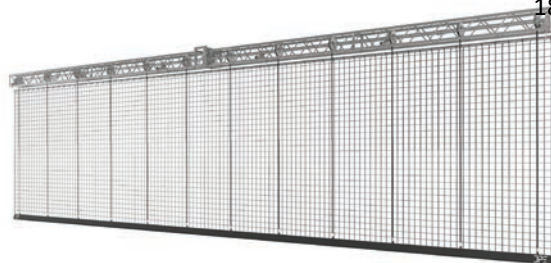
**S07610**

Rete divisoria e di protezione per campi gioco a maglia cm 10x10 per tutta l'altezza, scorrimento manuale su binario

Play-courts dividing and protective netting, mesh 10x10 cm, for the whole height, manually closing to the side on rail

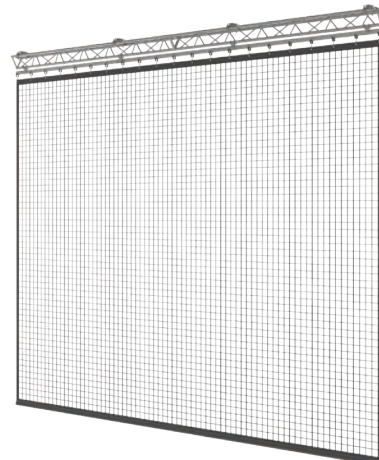
**S07611**

Tenda divisoria per campi da gioco realizzata in materiale sintetico ignifugo a singolo telo, scorrimento manuale su binario

Play-courts dividing curtain made of synthetic fireproof PVC, single layer, manually closing to the side on rail

**S07612**

Tenda divisoria per campi da gioco realizzata in tessuto ignifugo a singolo telo, scorrimento manuale su binario

Play-courts dividing curtain made of fireproof fabric, manually closing to the side on rail



S07613

Tenda divisoria combinata per campi gioco realizzata in materiale sintetico ignifugo a singolo telo per cm 270 da terra e rete a maglia cm 10x10 per la restante altezza, scorrimento manuale su binario

Play-courts combined dividing curtain made of synthetic fireproof PVC, single layer, for 270 cm on bottom part and 10x10 cm net on upper side, manually closing to the side on rail

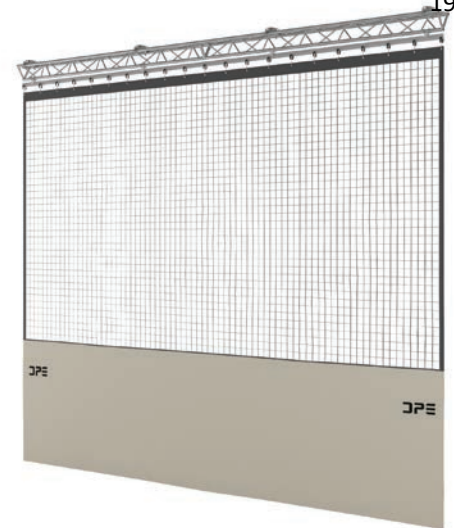
**REFERENZE**

Bolzano - ITALY



Caorle - ITALY



Oyrabakki - FAROE ISLANDS

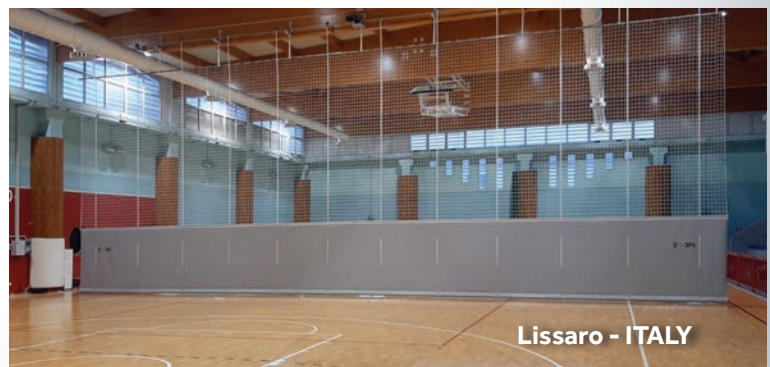

Lissaro - ITALY

S07620

Pannello divisorio in PVC colorato su struttura di supporto in acciaio verniciato e zincato con sistema telescopico di regolazione dell'altezza, mobile su ruote (con freno), lunghezza cm 300 ed altezza massima cm 220

Colored PVC dividing panel with varnished and galvanized steel structure telescopically adjustable in height, mobile on wheels (with brake), length 300 cm with maximum height 220 cm





S07652 + S07654 + S07656

S07652

Tribuna fissa per interni con struttura di acciaio verniciato, piani seduta di legno o a scocche di polipropilene, corridoi e scale di accesso secondo normativa corrente; personalizzabile a richiesta nei particolari

Fixed grandstand for indoor use with varnished steel structure, seating area made of wood or coloured polypropylene seats, walkways and stairways accordingly to current rules; can be customized on demand



S07652 + S07654 + S07656

S07654

Parapetto laterale in acciaio verniciato per tribuna S07652
Lateral hand rails made of varnished steel for grandstand S07652

S07656

Parapetto posteriore in acciaio verniciato per tribuna S07652
Back hand rail made of varnished steel for grandstand S07652



S07652 + S07654



S07652 + S07654

NOTE

Tribuna S07652 personalizzabile nella scelta cromatica, nell'allestimento e nelle finiture: seduta di legno o a scocche di polipropilene con o senza schienale ... pannelli di camminata in legno antiscivolo, in acciaio grigliato o alluminio ... eventuale tamponamento frontale e laterale in legno o alluminio ...

Grandstand S07652 can be customized with a range of colours. Fittings and finishing: seating elements in wood or colored polypropylene seats with or without backrest ... walkways with non-slip surfaces or steel grill or aluminum surface ... eventual vertical closing panels in wood or aluminum ...



S07658 + S07660 + S07662

**S07658**

Tribuna fissa per esterno con struttura di acciaio zincato, sedute in polipropilene, corridoi e scale di accesso secondo normativa corrente

Fixed grandstand for outdoor use with galvanized steel structure, coloured polypropylene seats, walkway and stairway according to current rules

S07660

Parapetto laterale in acciaio zincato per tribuna S07658
Lateral hand rails made of galvanized steel for grandstand S07658

S07662

Parapetto posteriore in acciaio zincato per tribuna S07658
Back hand rail made of galvanized steel for grandstand S07658

Tribuna S07658 personalizzabile a richiesta nell'allestimento e nelle finiture. In foto tribuna a 3 gradoni con sedute ribaltabili in polipropilene, modello S07694.

Grandstand S07658 can be customized on demand on fittings and finishing. Side pictures are showing a 3 steps grandstand equipped with tip-up polypropylene seats, model S07694.

**NOTE**

COSTA RICA

**S07664**

Tribuna telescopica per interni a movimentazione manuale o elettrica, struttura di acciaio verniciato, piani di seduta di legno o a scocche di polipropilene, corridoi, scale e parapetti secondo normativa corrente, totalmente personalizzabili nelle dimensioni e nelle finiture

Telescopic grandstand for indoor use manually or electrically operating, varnished steel structure, seating area made of wood or coloured polypropylene seats, walkways, stairways and hand rails according to current rules, entirely customizable on dimensions fittings and finishing



S07666

S07666

Tribuna VIP componibile e trasportabile realizzabile mediante affiancamento di moduli seduta e moduli scala; ciascun modulo con struttura in acciaio verniciato, piani di calpestio in legno trattato con finitura antiscivolo e ruote gommatae installate in modo da permettere l'agevole spostamento del modulo una volta ribaltato. Il modulo seduta consta di nr 6 poltrone VIP, personalizzabili nei colori, modello Master Mini 28 con sedile tip-up, distribuite su 3 gradoni. Il modulo scala consta di 2 scalini di accesso e 2 sedute del modello succitato disposte sul gradone più alto

VIP modular and portable grandstand to be realized by alternation of different quantities of seating and step modules; each module is made of epoxy painted steel construction, is equipped with walkways made of special non-slip finished wooden panels and rubberized wheels useful for rolling away the module itself once tipped-up on side. Seating module is equipped with 6 VIP tip-up armchairs model Master Mini 28 distributed in 3 steps. The steps module has 2 access step and 2 VIP seats on the top level



S07668

**S07668**

Modulo tribuna da mt 2 a 3 file di seduta con 12 scocche di polipropilene colorato su struttura in acciaio verniciato (colore a richiesta), ribaltabile e mobile su ruote per stoccaggio
Compact stand for indoor use 2 mt with 3 steps and 12 coloured polypropylene seats mounted onto varnished steel structure (color on demand), foldable and mobile on wheels for storing

S07669

Modulo scala con larghezza cm 120 per tribune mobili da interno S07668 e S07672
Stairway module 120 cm width for portable indoor stands S07668 and S07672



S07670

**S07670**

Modulo tribuna da mt 2 a 3 file di seduta con 12 scocche di polipropilene colorato su struttura in acciaio zincato, per uso interno ed esterno, ribaltabile e mobile su ruote per stoccaggio

Compact stand for indoor and outdoor use 2 mt with 3 steps and 12 polypropylene seats mounted onto galvanized steel structure, foldable and mobile on wheels for storing

S07671

Modulo scala con larghezza cm 120 per tribune mobili da esterno S07670

Stairway module 120 cm width for portable outdoor stands S07670



S07672

**S07672**

Modulo tribuna da mt 2 a 3 file di seduta a pannelli di legno su struttura in acciaio verniciato (colore a richiesta), ribaltabile e mobile su ruote per stoccaggio

Compact stand for indoor use 2 mt with 3 steps and wooden seating area mounted onto varnished steel structure (color on demand), foldable and mobile on wheels for storing



S07678

S07678

Tribuna componibile da mt 10 costituita di 4 moduli di seduta più un modulo con scalini di accesso, accostabili tra loro secondo qualsiasi ordine, ribaltabili e mobili su ruote, stoccabili a scomparsa uno nell'altro grazie alla diversa lunghezza dei moduli stessi (cm 280, 240, 200, 160 e 120); struttura in acciaio verniciato (colore a richiesta), pannelli di seduta in legno verniciato, pannelli di camminata in legno con finitura antiscivolo; poggia-schiena abbattibile integrato nell'ultima fila di seduta; per uso interno

Portable stackable grandstand with total length of 10 mt made of 4 seating modules and one module with access steps that can alternate in any different positions; each module can be tipped-up and rolled away on proper wheels installed on back side of structure; different modules can be stocked on wheels one inside the others thanks to the different length (280, 240, 200, 160 and 120 cm); varnished steel structure (color on demand), varnished wooden panels on seating area, anti-slip surface wooden panels on walking area and steps; foldable backrest on last seating row; for indoor use

S07679

Tribuna componibile da mt 10 come articolo S07678, con struttura in acciaio zincato e pannelli di seduta e camminata realizzati in legno trattato per uso esterno

Portable stackable grandstand with total length of 10 mt as article S07678, galvanized steel structure and wooden panels on seating and walking areas specially treated for outdoor use



S07679

FOTO DEL MODULO DA CM 200

PICTURE OF 200 CM MODULE



S07680

**S07680**

Modulo tribuna per esterno completamente in acciaio zincato con scalino di accesso e 2 file di sedute a scocche di polipropilene per un totale di 7 posti

Compact stand for outdoor use entirely made in galvanized steel with stairway and walkway, 2 steps with total 7 places equipped with polypropylene seats

S07682

Modulo tribuna per esterno in acciaio zincato e verniciato con scalino di accesso e 2 file di sedute a scocche di polipropilene per un totale di 7 posti, con personalizzazione 3ON3 (vedi pagina 139)

Compact stand for outdoor use entirely made in galvanized and varnished steel with stairway and walkway, 2 steps with total 7 places equipped with polypropylene seats, customized 3ON3 (refer to page 139)



S07682

**S07684**

Copertura per gradoni tribuna realizzata in tavole di legno verniciato con trattamento ignifugo

Cover for stand's steps made of fireproof varnished wooden panels



S07684

**S07690**

Scocca di seduta senza schienale in polipropilene ignifugo colorato, fissaggio diretto al gradone
Fireproof colored polypropylene seat without backrest, to be directly fixed to concrete step

**S07692**

Scocca di seduta con schienale in polipropilene ignifugo colorato, fissaggio diretto al gradone
Fireproof colored polypropylene seat with backrest, to be directly fixed to concrete step

**S07694**

Scocca di seduta ribaltabile con sedile e schienale in polipropilene colorato ignifugo, montati su telaio in poliammide per fissaggio fronte gradone
Tip-up seat with seating and backrest elements in colored fireproof polypropylene mounted on polyamide structure that can be riser fixed to concrete step

NOTE

Articoli **S07690**, **S07692**, **S07694** disponibili in vari colori, per informazioni sulla disponibilità: info@sportssystem.it

Articles **S07690**, **S07692**, **S07694** available in different colors, for info about availability: info@sportssystem.it

**S07696**

Poltrona VIP per gradinate di stadi e palazzi dello sport disponibile in vari modelli marchiati "Sport System by Lino Sonego", tutti personalizzabili a richiesta nella scelta dei colori e con il ricamo di eventuali loghi
VIP armchair for football stadium and indoor sport halls' stands available in different models branded "Sport System by Lino Sonego", all of them customizable on colors selection and by embroidering any logos

NOTE

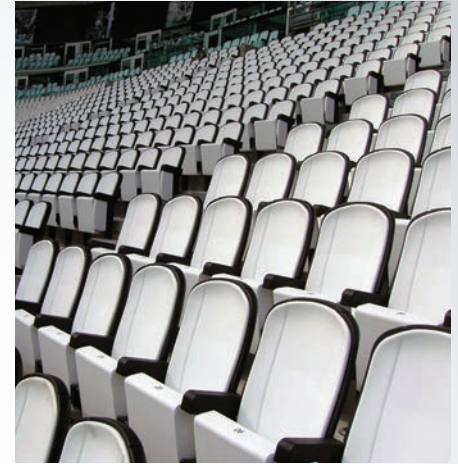

SEDUTE VIP "SPORT SYSTEM BY LINO SONEGO"

Sport System arreda con stile ed eleganza le gradinate VIP di stadi outdoor ed arene indoor con oltre 10 diversi modelli di poltrone totalmente personalizzabili. Per maggiori informazioni e per richiedere un preventivo contattare info@sportssystem.it



VIP ARMCHAIRS "SPORT SYSTEM BY LINO SONEGO"

Sport System equipa with style and elegance the VIP areas of main outdoor stadium and indoor sports arenas with more than 10 different models of armchairs totally customizable. For more info and to require an offer contact info@sportssystem.it



**S07700**

Transenna di acciaio zincato con piedi di appoggio a terra, dimensioni cm 200x100, con sistema di aggancio a catena
Tubular galvanized steel barrier 200x100 cm, free standing model, with connection joints

**S07710**

Transenna in plastica con piedi di appoggio a terra ruotabili, dimensioni cm 215x90, con banda catarifrangente, con sistema di aggancio a catena
Plastic barrier with pivoting feet, dimensions 215x90 cm, with reflecting adhesive band and connection joints

**S07712**

Transenna divisoria per palestre realizzata in acciaio verniciato, dimensioni indicative del singolo elemento cm 200x100, disponibile nella soluzione a bussole o con piastre da tassellare a pavimento; personalizzabile
Dividing barrier for indoor sport hall made in varnished steel, indicative dimensions of each element 200x100 cm, available in sockets solution or with ground fixing plates; can be customized

**S07713**

Sistema di protezione per transenna divisoria realizzato con elementi sagomati di gomma espansa, rivestiti in PVC colorato
Shaped protective pad modules for dividing barrier made of soft foam covered in PVC



S07715

S07715

Spazzolone per pulizia ed asciugatura area pubblico e campo di gioco

Scrubber for cleaning spectators' area and playcourt

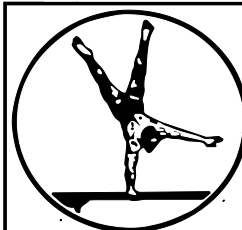
**BVBA SPORTA DE WAELE**

Gentsesteenweg 190

9240 ZELE-België/Belgique/Belgium

Fabriek van sport-, turn- & fitnessstoestellen

☎ 052/44 43 38

✉ sportadewaele@skynet.be

**S07720**

Macchina motospazzatrice "uomo a bordo" per tutte le superfici, funzionante con batteria ricaricabile

Ride-on vacuum sweeper for all type of surfaces, working with rechargeable battery

**S07725**

Macchina lavasciuga pavimenti manuale, funzionante con batteria ricaricabile

Manual washing machine working with rechargeable battery





SPORT SYSTEM
WWW.SPORTSYSTEM.IT®

Dal 1979 Sport System progetta, produce, distribuisce ed installa, in Italia e nel resto del mondo, una **vasta gamma di attrezzature ed articoli sportivi per la ginnastica, l'atletica, gli sport individuali e di squadra**. La **qualità dei materiali** utilizzati, il **design degli articoli progettati e prodotti**, il **rispetto delle norme di sicurezza** e dei regolamenti tecnici internazionali di ogni singolo sport, il servizio pre e post vendita garantiscono la massima soddisfazione tanto delle richieste del cliente istituzionale quanto dei bisogni del sempre più esigente atleta professionista. L'ampia offerta di **Sport System** comprende altresì una linea articolata e completa di **arredi ed accessori** per i vari locali annessi all'area di gioco quali **spogliatoi, infermerie, sale stampa e sale riunioni, tribune e gradinate**. Tutto questo, oltre alla possibilità di personalizzare qualsiasi articolo secondo le esigenze del cliente, permette all'azienda di offrire ai propri interlocutori la possibilità di arredare qualsiasi struttura sportiva nella sua interezza e secondo le più svariate necessità. Nella continua tensione ad una costante soddisfazione dei propri clienti **Sport System** è stata la prima azienda italiana del settore ad aver implementato un sistema qualità aziendale ed è attualmente in possesso della certificazione di qualità secondo la norma **UNI EN ISO 9001/2015**.

Da sempre specializzata nella produzione di innovativi impianti basket omologati per competizioni internazionali, forte di **oltre 40 anni di esperienza** pratica e progettuale, **Sport System è partner del FIBA "Equipment & Venue" Centre** (già "FIBA Research & Study Centre") e fornitrice delle più prestigiose squadre di basket italiane ed estere. Gli impianti basket di Sport System sono già stati utilizzati in occasione di molteplici eventi internazionali organizzati da FIBA, sia in Italia che nel resto del mondo.

Da oltre 20 anni il marchio **Sport System** è presente anche nei principali stadi internazionali dove sono state installate le **panchine VIP** personalizzate per riserve ed allenatori riconoscibili dal design e lo stile tipicamente italiani e dall'elevata cura dei particolari.

Recentemente l'offerta è stata ampliata con l'introduzione di una linea di sistemi di **suddivisione degli spazi** (conosciuti anche con il termine di **tende divisorie**), sia manuali che motorizzati, sempre più richiesti al fine di garantire la divisione degli ambienti ed il rispetto del distanziamento tra gli utilizzatori di una stessa struttura.

Maggiori informazioni relativamente all'azienda, alla propria offerta e alle referenze conseguite si possono acquisire visitando il **sito internet aziendale www.sportsystem.it** ed in particolare la pagina **referenze** e la pagina **pubblicazioni** dalla quale sono scaricabili il file pdf del catalogo aggiornato, della lista referenze, di alcuni dépliant e altri utili documenti.



SPORTSYSTEM
WWW.SPORTSYSTEM.IT

Since 1979 Sport System has been designing, manufacturing, trading and installing, in Italy and internationally, a wide range of gym and fitness accessories and sports equipment for gymnastics, athletics, individual and team sports. The quality of materials used, the design of equipment produced, the respect of each sports single technical requirements, the service provided both before and after sales, has all been helping Sport System to achieve both the requirements of institutional customers as well as the needs of the more sophisticated professional sportsmen. The wide Sport System's catalogue also includes a complete range of furnishing and accessories for spectator's areas, changing rooms, infirmaries, meeting and press rooms allowing customers to completely equip an entire sport complex. Always focusing on customer satisfaction, Sport System has been the first Italian company in this sector to implement a high quality system that is now certified according to UNI EN ISO 9001/2015.

Specialized in basketball and with more than 40 years of experience in designing and manufacturing top quality professional basketball backstops approved for International competition, Sport System is a FIBA "Equipment & Venue" (former "FIBA Research & Study Centre") partner as well as the official supplier of some of the most prestigious basketball clubs and basketball arenas worldwide. Having reached a leadership position in the world market of sport equipments and with the consolidation of its own trademark among the leading international suppliers of basketball equipment, not only represent for Sport System an important acknowledgement but is the recognition of the efforts and continuous commitment to improve the products and services offered.

For more than 20 years the Sport System's brand has also proved popular for major International soccer stadiums where the customized VIP team shelters have been installed and are easily recognizable by the finest Italian design and style as well as the high attention to detail.

During a time where the division of spaces and social distancing between people are important factors in the management of sport facilities, Sport System presents a new line of dividing curtains that is in constant evolution and expansion to fit requirements of any different sports facility.

For more info and news about company and its offer, the company's website www.sportssystem.it is available and constantly updated.



ŠIRVINTOS - LITHUANIA



MAZZANO - ITALY



VARESE - ITALY

AUSTRALIA Adelaide - Coopers Arena :: Adelaide 205 / 210
 Shores Football Centre :: Broadbeach - Gold Coast Convention & Exhibition Centre :: Perth - Perth Arena :: Victoria - Geelong Arena |
AUSTRIA Klagenfurt - United World Games 2019 |
AZERBAIJAN Baku - Central Stadium Tofik Bakhranov :: Baku - Central School N 134 |
BELARUS Minsk - Palova Arena :: Pinsk - Volna Arena |
BELGIUM Brussels - Palais 12 - Brussels Expo :: Charleroi - Spiroudome :: Merksem - Lotto Arena :: Oostende - Versluys Dôme | **BOLIVIA** Sucre - Estadium Olimpico Patria :: Tarija - Gran Guadalquivir Basquetbol |
BOSNIAHERZEGOVINA Banja Luka - Gradski-Stadion :: Laktasi - Laktasi Sport Hall :: Mostar - F.C. Zrinjski Stadium :: Zenica - Stadion Bilino Polje :: Zenica - Zenica Arena |
BULGARIA Pleven - Balkanstroy Sport Hall :: Samokov - Samokov Arena :: Sofia - 3X3 Court | **CANADA** Calgary - Talisman Centre :: Waterloo - Physical Activities Complex - University of Waterloo | **COSTA RICA** Cartago - Colegio Miravalle :: Limon - University of Costa Rica | **CROATIA** Osijek - Dvorana Gradski VRT Osijek :: Pula - Gradski Stadion Aldo Drosina :: Rijeka - Kantrida Stadium :: Zara - Zara Municipal Sport Hall | **CYPRUS** Limassol - Melford Arena :: Limassol - Multifunctional Sea Park (OPAP Limassol 3ON3 2019) :: Nicosia - Achilleas Kaimakliou Sport Hall | **CZECH REPUBLIC** Opava - BK Opava Multipurpose hall :: Pardubice - MFA Pardubice | **EGYPT** Cairo-Alexandria-Suez - Africa Cup of Nations - Egypt 2019 :: Giza - Shooting Club Sport Hall | **ESTONIA** Rapla County - Sport Hall Kohila :: Tartu - Le Coq Sport Hall :: Tallin - Tallin Arena | **FINLAND** Lohja - Kisakallio Susi Training Center :: Vantaa - Energia Hall | **FRANCE** Antibes - Sport Hall Azur :: Lorient - Palais de Sport :: Nancy - Palais des Sports Jean Weille :: Villeurbanne - Astroballe | **GEORGIA** Tbilisi - Georgian Basketball Federation Sporthall :: Tbilisi - Ministry of Defence Sporthall :: Tbilisi - Tbilisi Challenge 3X3 | **GREECE** Athens - Peace & Friendship

Stadium ::: Crete - Heraklion arena ::: Kefalonia Island - Argostoli Sport Hall ::: Peristeri / Athens - Papandreou Hall ::: Thessaloniki - Palais de Sport' Thessaloniki | **HUNGARY** Budapest - Fiba Europe 3X3 Tour ::: Kisvárda - Kisvarda Stadium | **INDIA** New Delhi - J. Nehru Olympic Stadium | **IRAQ** Al-Kut - Al-Kut Olympic Stadium ::: Baghdad - Al Shaab Stadium ::: Baghdad - Alshuhadaa International Stadium ::: Duhok - Duhok University ::: Zakho - Zakho International Stadium | **ITALY** Bologna - Virtus Arena ::: Bologna - Palestra Porelli - Virtus Bologna ::: Bologna - LNP Coppa Italia 2017 ::: Bologna - Sport Hall Paladozza ::: Bolzano - University of Bolzano ::: Brescia - PalaLeonessa ::: Caorle - Palaexpomar ::: Cervia - Palazetto dello Sport ::: Conegliano - Zoppas Arena ::: Cortina - Olympic Ice stadium ::: Firenze - Final Eight Coppa Italia 2018 ::: Gorizia - Palestra Istituto Cankar ::: Ischia - Forio Sport Hall ::: Jesolo - Pala Arrex ::: Leini - Cittadella dello Sport ::: Lignano - FIBA 3X3 Nations League 2019 ::: Livorno - Pala Livorno ::: Mestrino - Palestra di Lissaro ::: Milano - Allianz Cloud Arena - Palalido ::: Milano - Recreation and Sports Center - Università Bocconi ::: Montichiari - PalaGeorge ::: Napoli - Summer Universiade 2019 ::: Pesaro - Vitfrigo Arena (Final Eight 2020 Coppa Italia) ::: Reggio Emilia - Pala Bigi ::: Riccione - Streetball Italian Tour 2018 ::: Rimini - Final Eight Coppa Italia 2017 ::: Rimini - Romeo Neri Stadium ::: San Vendemiano - PalaSport System ::: Settimo Torinese - Istituto 8 Marzo ::: Torino - Sport Hall Russel/Moro ::: Trento - Pala Trento ::: Treviso - PalaVerde Arena ::: Trieste - Allianz Dome ::: Verona - Marc'Antonio Bentegodi Stadium ::: Venezia - Taliercio Sport Hall | **JAPAN** Ohta - Ohta Citizen Gymnasium ::: Okinawa - Okinawa Sport Hall ::: Sendai - Xebio Arena | **JORDAN** Amman - Amman International Stadium ::: Amman - Prince Faisal Sport Hall ::: Amman - King Abdallah II Stadium | **KAZAKHSTAN** Astana - Saryarka Velodrome ::: Temirtau - Arcelor Mittal



ZADAR - CROATIA



ANTIBES - FRANCE

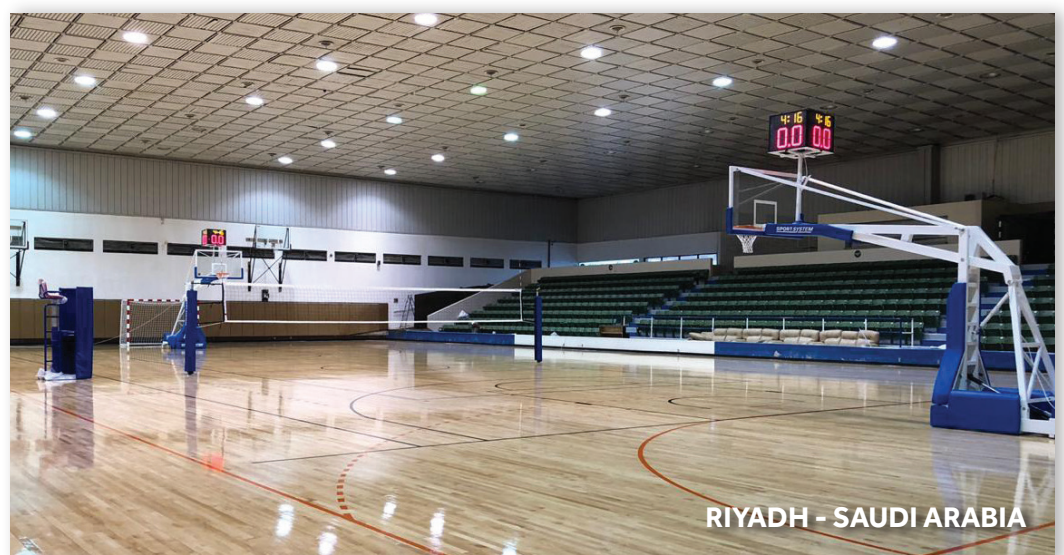

RIYADH - SAUDI ARABIA



BRESCIA - ITALY



KISVARDÁ - HUNGARY



LISBON - PORTUGAL



MURSKA SOBOTA - SLOVENIA

Sport Hall | **KIRIBATI** Tarawa 207 / 210

- Betio Sports Complex | **KYRGYZ REPUBLIC** Kara-Suu Town - Gazprom FOK | **LATVIA** Riga - Fiba Europe 3X3 Tour :: Riga - Daugavas stadions :: Riga - New Riga Arena :: Saldus - Saldus Sport Hall | **LITHUANIA** Gargždai - Gargzdu miesto sporto sale :: Vilnius - Šarunas Marciulionis Basketball Academy | **MACEDONIA** Skopje - Philipp II Stadium | **MALAYSIA** Miri-Sarawak - Shin Yang Group Outdoor Basketball Court | **MAURITIUS** Côte d'Or - Multisport Complex | **MONTENEGRO** Podgorica - Podgorica City Stadium | **MOROCCO** Agadir - Stade Adrar :: Al Hoceima - Stadium Mimoun Al Arsi :: Casablanca - Stade Mohammed V :: Marrakech - Grand Stade de Marrakech :: Rabat - Complexe Sportif Prince Moulay Abdellah | **MOZAMBIQUE** Maputo - Maxaquene Stadium | **NETHERLAND** Groningen - MartiniPlaza Topsportarena :: Noordwijk - Northgo Sport Hall | **NEW ZEALAND** North Island - Arena Manawatu - :: North Island - Rotorua Events Centre | **NIGERIA** Benin City - University Of Benin Indoor Sport Hall :: Zaria - Ahmadu Bello University | **OMAN** Mana - Recreational Center :: Muscat - Nizwa Sport Complex :: Muscat - Sohar Sport Complex :: Saham - Saham Sports Club | **PANAMA** Panama City - Rommel Fernandez Stadium | **PERU** Tacna - Coliseo Peru | **POLAND** Rzeszow - Northgo Sport Hall | **PORTUGAL** Lisbon - Complexo Desportivo do Estádio Sport Lisboa e Benfica :: Oporto - Dragao Arena | **QATAR** Al Khor City - Dhakira Club :: Doha - Qatar Foundation :: Doha - Sport City-Basketball Indoor Hall | **ROMANIA** Arad - Uta Stadium :: Bucarest - Dinamo Stadium :: Bucharest - Fiba Europe 3X3 Tour :: Cluj Napoca - Cfr Stadium :: Cluj-Napoca - FIBA EuroBasket 2017 :: Craiova - Ion Oblemenco Stadium :: Iasi - Emil Alexandrescu Stadium :: Sibiu - Liceul Bruckenthal :: Timisoara - Politecnico Timisoara Stadium | **RUSSIA** Kaliningrad - MOST - Public Space :: Kazan - Kazan Arena :: Krasnodar - Basketball Sporthall :: Moscow - Fiba

Europe 3X3 Tour ::: Moscow - Luzhniki Olympic Stadium ::: Mytishchi-Moscow - Mytishchi Arena ::: St. Petersburg - Yubileiny Sports Palace ::: St. Petersburg - Zenit Academy | **RWANDA** Kigali - Kigali Arena | **SAUDI ARABIA** Burayda - Al Taawoun Sports Club ::: Madina - Alansar Club ::: Riyadh - Hilal Club | **SERBIA** Aleksinac - Src Srca | **SENEGAL** Dakar - Senegal Arena | **SINGAPORE** Singapore - Sportshub | **SLOVAKIA** Piešťany - Diplomat Arena | **SLOVENIA** Celje - Arena Petrol ::: Domzale - Stadium NK Domzale ::: Koper - Bonifica Arena ::: Koper - Stadium Bonifica ::: Kranj - Stanko Mlakar stadium ::: Ljubljana - Fiba Europe 3X3 Tour ::: Ljubljana - Stozice Arena ::: Maribor - Vrt Stadion ::: Murska Sobota Fazanerija City Stadium | **SOUTH AFRICA** Johannesburg - Wembley Basketball Stadium | **SPAIN** Alicante - Onil 3X3 ::: Canary Island - Fiba Europe 3x3 Tour ::: Cartagena - Palacio de los Deportes ::: Ibiza/San Antonio de P. - Complejo polideportivo Can Coix ::: Las Palmas De Gran Canaria Fiba Europe 3X3 Tour ::: Valencia - Levante Union Deportiva Stadium | **SWEDEN** Solna - Friends Arena ::: Stockholm - Stockholms Olympiastadion | **SWITZERLAND** Mies - Skatepark et Basket 3x3 | **TUNISIA** Rades - FIBA AfroBasket 2017 ::: Tunis - Salle Omnisport 'El-Gorjani' ::: Tunis - Palais des Sports El Menzah | **TURKEY** Antalya - Antalya Arena ::: Istanbul - Cebeci Sport Hall ::: Rize - Rize Yeni Kapali Spor Salonu ::: Yalova - Yalova Sport Hall | **U.A.E.** Abu Dhabi - Al-Nahyan Stadium ::: Abu Dhabi - Mohamed Bin Zayed Stadium ::: Al Ain - Sheikh Khalifa International Stadium | **UKRAINE** Donetsk - Donbass Arena ::: Kiev - Sport Palace Kiev | **UNITED KINGDOM** London - Nike Regal Centre ::: London - Ravenscourt Park ::: London - University of East London ::: Manchester - Manchester University | **VENEZUELA** Varga - III Beach Sudamerican Games Varga.



